



 **heidolph**  
**MADE IN GERMANY**

Premium Laboratory Equipment

**2018**

Leading Safety Standards

Superior Ease of Use

Reduced Cost of Ownership

 **heidolph**  
research made easy

## Support made easy

**While you concentrate on research, we'll look after your support needs**  
As we want you to have more time to concentrate thoroughly on your research, the whole Heidolph team enthusiastically provides you with extensive support and helps to reduce your workload.

[www.heidolph.com](http://www.heidolph.com)

## What's in it for me?

Watch our **corporate video** and learn about all benefits and services of Heidolph and our partners!

Available at [www.heidolph.com](http://www.heidolph.com) and on our **Youtube-Channel!**



### Our Service Commitment:

- Guaranteed response to any request within 24 hours
- Lead times below 2 weeks for standard equipment
- Free demo evaluation units for up to 14 days
- Repair turn-around time within 4 working days
- The most common spare parts are locally available
- Immediate after-sales service provided by more than 80 distributors worldwide
- Installation and training on site
- Application support by chemists

### Our Quality Commitment:

- Increased lifespan of 10 years on average
- Reduced maintenance and spare parts cost over the entire lifespan
- Long-lasting service life of all products due to corrosion-resistant electronics and maintenance-free motors
- Low product failure rates

**3-year warranty - without compromises**



**As a leading manufacturer of laboratory equipment, we are an innovative and globally active company. With a local footprint in more than 80 countries, we support pharmaceutical research, the cosmetics industry, the biology as well as the chemistry sector with our products and services, significantly contributing to improving the quality of people's lives all over the world.**

Our organization is headquartered in Schwabach, a city within close proximity to Nuremberg, Germany. It is here that the development and production of our equipment as well as the coordination of our domestic and international sales, marketing and customer support activities take place.

Respect for the personal and professional development of our employees has created a strong commitment to success, resulting in a dynamic period of growth and prosperity for the Heidolph organization. As a result, the Heidolph team is continuously striving to achieve industry-leading product quality and customer service while maintaining a strong customer-focused approach to developing products and services that help to improve the efficiency of scientific research.



MADE IN  
GERMANY

## Made in Germany

“Made in Germany” is an internationally recognized quality seal for reliability, long performance life and low failure rates. In an era of accelerated economic globalization this is becoming an important competitive factor. Heidolph Instruments is committed to designing and manufacturing premium high-quality products exclusively in Germany.

For all components, Heidolph has defined the highest quality standards: Maintenance-free motors “Made in Germany” eliminate down times, frequent warranty periods and costly repairs – it’s for these reasons that we stand behind our products designed to provide you years of continuous operation. Our Germany-based R&D and production facilities allow for responding to customer requests quickly.

This accounts for product adjustments and for production volume equally. A high level of innovation in combination with short lead times make your Heidolph purchase a truly worthwhile investment, considering the average operational lifespan of 10 years!



## Summary

<b>Hei-VAP Rotary Evaporators</b> Intelligent Evaporation	➤ 10
<b>Hei-VAP Industrial Large-Scale Rotary Evaporators</b> Industrial Evaporation	➤ 36
<b>Hei-VOLUME Automatic Modules</b> Automated 24/7 Evaporation	➤ 50
<b>Hei-PLATE Magnetic Stirrers</b> Safe Heating and Mixing	➤ 62
<b>Hei-TORQUE Overhead Stirrers</b> Powerful Stirring	➤ 82
<b>Hei-MIX Shakers and Mixers</b> Temperature-Controlled Shaking	➤ 100
<b>Hei-FLOW Peristaltic Pumps</b> Precise Dosing and Dispensing	➤ 122
<b>Hei-Lab App - Technical Service</b>	➤ 144
<b>ISO Certificate</b>	➤ 146
<b>Premium Distributors</b>	➤ 147
<b>Imprint</b>	➤ 149

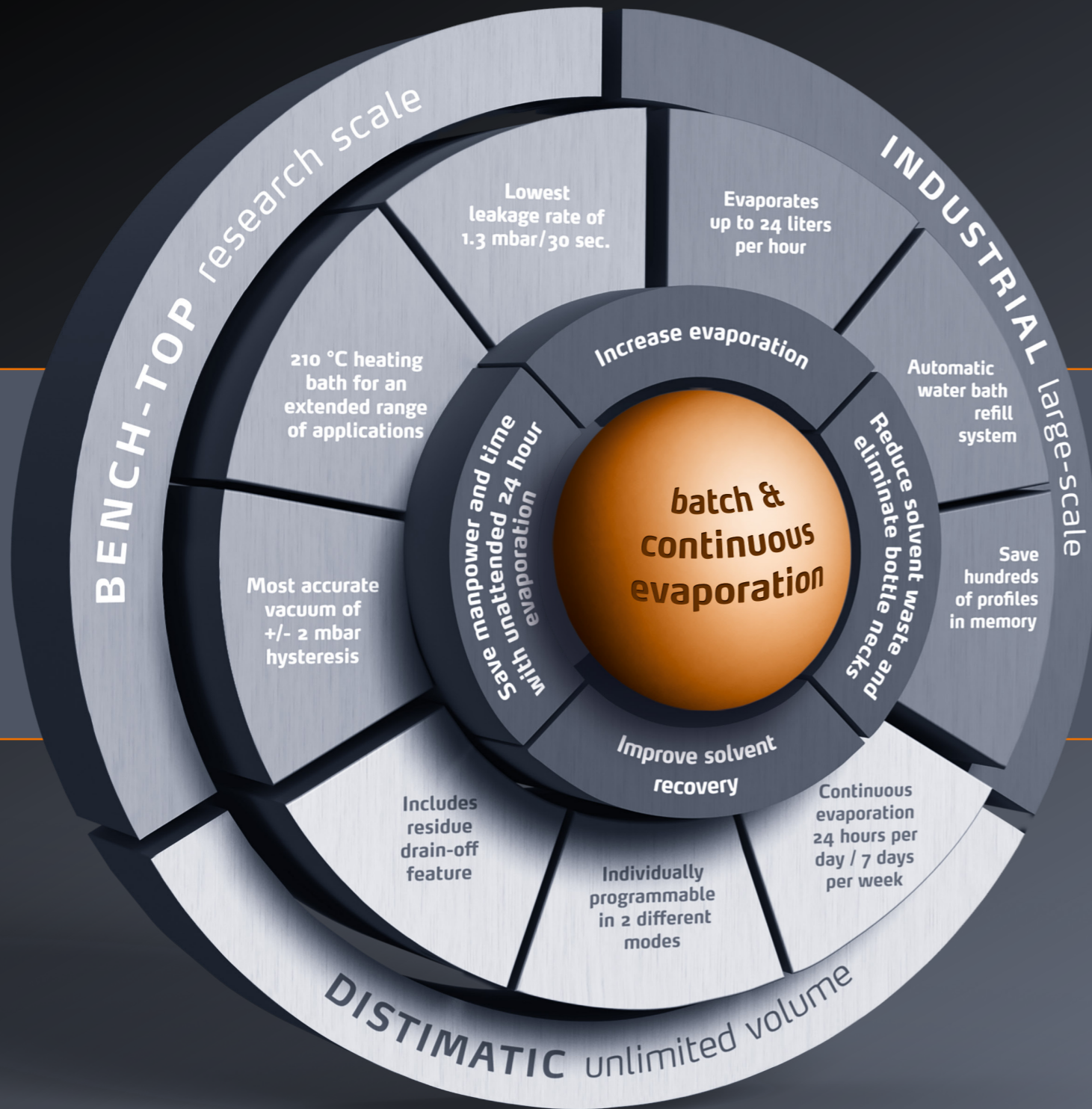

# Improve your evaporation process

# Intelligent Evaporation



## Hei-VAP Rotary Evaporators

Leading Safety Standards

Superior Ease of Use

Reduced Cost of Ownership



Do you demand the highest safety standards, perfectly engineered ease of use and reduced cost of ownership?

## Intelligent Evaporation...

... stands for an overheat protection design that prevents water baths running dry, provides a detachable panel for superior ease of use from outside closed fume hoods and offers a proven vacuum seal and vapor tube system guaranteed for years of operation!



## Leading Safety Standards

- Two independent safety circuits **avoid an overheat situation** of your heating bath: If bath temperature overshoots by 5 °C and if your water bath runs dry, heating will be switched off automatically
- To **avoid** an overtemperature situation and potential **thermal damage** to your sample, you can individually pre-program a maximum temperature on the Hei-VAP Precision, at which the bath powers off
- In case of a power cut, all motor lift models will remove the flask from the heating bath **preventing safety hazards** and potential thermal damage to your sample
- To **protect you from splashes and scalding**, the Hei-VAP heating bath features an integrated pour spout to remove bath fluid safely
- Heating bath is constructed with a **double wall** for your protection against burns and scalding
- The **guard hood covers the bath** even if the heating bath is adjusted horizontally to its most extreme limit
- A **metal guide** between the heating bath and the base unit **prevents bath instability**
- To **protect** your heating bath **against short-circuits and systematic corrosion**, the cable coupling complies with the protection class IP 67
- For your protection, the operating panel is located underneath a protective canopy so as to **keep your hands out of the dangerous zone** of rotating flasks, steam and splashing bath fluids
- All heating baths feature **non-slip handles** with safety grip to protect you from scalding bath liquids and allow for easy installation/removal of the bath
- A separate on/off switch for heating **prevents unintentional heat-up**. The button is illuminated for visual control
- In case of an overshoot of any parameter setting, all models will show a **warning on the operating panel**
- Glassware assemblies are optionally available with **transparent plastic safety coating** ensuring ultimate protection while allowing visual control at all times
- IQ-OQ documentation** is available for Hei-VAP models on request

### ➤ Hei-VAP heating bath



#### YOUR ADVANTAGES

- The Hei-VAP heating bath reaches a temperature of 210 °C
- The universal heating bath can even accommodate 5-liter flasks
- The heating bath can be adjusted horizontally up to 200 mm
- To prevent short circuits and corrosion, the cable coupling complies with the protection class IP 67
- Non-slip handles for safe transportation eliminate the risk of scalding
- An integrated pour spout to remove bath fluid safely

## Superior Ease of Use

- The detachable operating panel enables convenient handling from **outside closed fume hoods**
- The patented evaporating flask **clamp Easy-Clip cannot be lost** due to a connection to the vapor tube coupling ring
- The integrated screwed ring allows you to **remove sticking evaporating flasks** from the vapor tube **just in seconds** in a safe manner
- The universal heating bath can be adjusted horizontally up to 200 mm and offers efficient space to **accommodate even 5-liter flasks**
- The innovative ventilation and replenishment valves no longer have ground joints, which **enables maximum tightness, grease-free operation and prevents glass breakage**
- For your convenience, **the height of 160 mm and the angle** of the evaporating flask **can be adjusted easily from 20° to 80°**
- The optional automatic module Distimatic Bench-top allows for **continuous and unattended automatic operations**
- All components in direct or indirect contact with the medium are equipped with **FDA-compliant materials for an extended application range**



## Reduced Cost of Ownership

- Achieve up to **40 % higher evaporation rates** due to unique tightness and industry-leading condensing surface with the **XL condenser**
- The high resistant and durable **PTFE vacuum seal achieves maximum tightness** and reduces spare part budgets
- The patented clamping sleeve ensures a **long life performance of the vapor tube**
- Increase your range of applications by using 5-liter flasks in the universal bath at **no additional cost**
- Maintenance-free and non-sparking motors **reduce repairs and down times significantly** to ensure years of continuous operation
- The flange on the condenser side of the drive is made of PPS (Polyphenylene sulfide), a robust industrial-designed resin with **superior chemical resistance** which provides more chemical resistance than stainless steel or welded aluminum. This reduces corrosion to a minimum which results in additional savings on maintenance and replacement components
- Spend your working hours more effectively on other challenges which require your attention and **evaporate large quantities continuously** with the automatic module Distimatic Bench-top
- Maximize your initial investment significantly: the automatic module Distimatic Bench-top is an **affordable and more flexible alternative** to large-scale rotary evaporators
- Reduce your maintenance costs. The sealed housing protects your rotary evaporator from aggressive fumes, liquids and vapors to prevent internal corrosion. This results in an **increased lifespan of 10 years** on average at a reduced maintenance and repair cost



# Intelligent Evaporation

Leading Safety Standards

Superior Ease of Use

Reduced Cost of Ownership

## Vapor tube with patented clamping sleeve

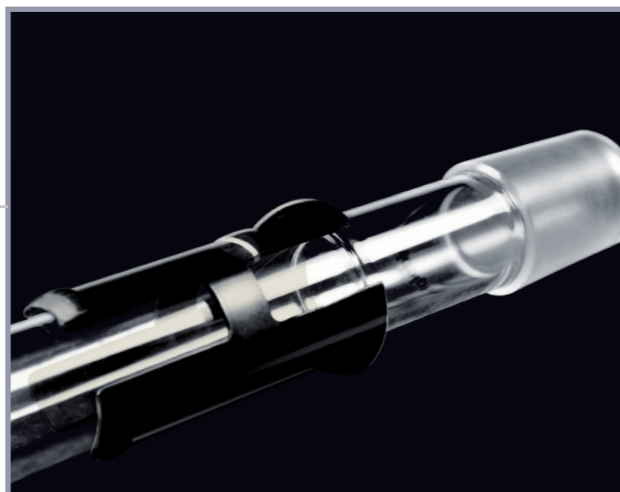

### YOUR ADVANTAGES

- The patented clamping sleeve system allows easy removal of the vapor tube from the drive
- Years of performance life reduce your spare parts budget up to 75 %
- The Hei-VAP vapor tube does not get stuck in the drive, thus eliminating the risk of broken glass
- Immediate removal of the vapor tube from the drive facilitates your work

## Patented flask clamp Easy-Clip



### YOUR ADVANTAGES

- Easy-Clip can't get lost due to a direct connection to the drive
- The integrated screw thread allows an easy removal of sticking flasks
- The Easy-Clip is made of highly resistant synthetic material which ensures a long life performance

## Operating panel



### YOUR ADVANTAGES

- Changing all parameters from outside closed fume hoods guarantees the highest safety level
- Standard for all models is a panel with 1 m cable connection. Thus data security is guaranteed at any time
- Immediate access to the panel ensures ultimate control of the process while increasing your ease of use
- A separate on/off switch for heating prevents unintentional heat-up – the button is illuminated for visual control

The average operational **lifespan of 10 years** is backed by a **3 year warranty** and makes your purchase a worthwhile investment.

New, FDA-compliant, transparent and uv-resistant tubing, with **higher chemical resistance**

Achieve **up to 40 % higher evaporation rates** due to tightness and industry-leading **2,200 cm<sup>2</sup>** condensing surface **with the XL condenser**

The new highly resistant PTFE vacuum seals allow for long lasting constant application and **reduce spare parts budgets**. Also available as FFKM version for application with extremely aggressive solutions



**Superior ease of use** due to the patented Easy-Clip, which provides an **easy removal of sticking flasks** and non-sticking vapor tube with patented clamping sleeve that **eliminates broken glass** and reduces spare parts cost significantly

The innovative ventilation and replenishment valves no longer have ground joints, which enables **maximum tightness, grease-free operation and prevents glass breakage**

**210 °C Safety heating bath** with handles and pour spout will power off if temperature overshoots by 5 °C or runs dry

The detachable operating panel enables **safe and easy handling** from outside closed fume hoods

Bath power cable coupling complies with protection class IP 67 to **prevent corrosion and short circuits**

**For unlimited evaporation:** In conjunction with the automatic module Distimatic Bench-top allows you unlimited and automated distilling in 24/7 operation. An affordable alternative to large-scale rotary evaporators

A separate on/off switch for heating **prevents unintentional heat-up** – the button is illuminated for visual control

A metal guide between the heating bath and the base unit **prevents bath instability**

## ➤ Hei-VAP Value / Hei-VAP Value Digital

### Superior ease of use due to direct control

The Hei-VAP devices with hand lift are optimally suited for all standard applications. Controlling parameters is done so with the simple turn of a knob

- The convenience of large dial controls for adjustment of rotation speed and bath temperature
- **Hei-VAP Value Digital** models come with a digital display for set and actual heating bath temperature



**Hei-VAP Value Digital HL/G3**  
P/N 560-01302-00

Model	Hei-VAP Value hand lift (HL)		Hei-VAP Value Digital hand lift (HL)	
	standard	coated	standard	coated
G1 Diagonal	560-01100-00	560-01110-00	560-01102-00	560-01112-00
G3 Vertical	560-01300-00	560-01310-00	560-01302-00	560-01312-00
G3 XL Vertical	560-01305-00	560-01315-00	560-01307-00	560-01317-00
G5 Dry Ice Condenser	560-01500-00	560-01510-00	560-01502-00	560-01512-00
G6 Vertical for Reflux	560-01600-00	560-01610-00	560-01602-00	560-01612-00

## ➤ Hei-VAP Advantage

### Wide range of possibilities for reproducible results

With the Hei-VAP Advantage you have a direct view on all parameter settings and are able to expand your application range

- Available in hand lift or motor lift configurations
- Experience the advantages of our large digital 3.5" LCD display which indicates rotation speed, heating bath and vapor temperature
- Experience the advantages of the automatic process timer which turns off your evaporator at a pre-programmed time and removes evaporating flasks from bath on motor lift models
- Upgrade your Hei-VAP Advantage to a Hei-VAP Precision:



**Hei-VAP Advantage ML/G3 XL**  
P/N 562-01305-00

**Upgrade-KIT**  
**Advantage Precision-HL**  
P/N 569-30009-00

**Upgrade-KIT**  
**Advantage Precision-ML**  
P/N 569-40009-00

Model	Hei-VAP Advantage hand lift (HL)		Hei-VAP Advantage motor lift (ML)	
	standard	coated	standard	coated
G1 Diagonal	561-01100-00	561-01110-00	562-01100-00	562-01110-00
G3 Vertical	561-01300-00	561-01310-00	562-01300-00	562-01310-00
G3 XL Vertical	561-01305-00	561-01315-00	562-01305-00	562-01315-00
G5 Dry Ice Condenser	561-01500-00	561-01510-00	562-01500-00	562-01510-00
G6 Vertical for Reflux	561-01600-00	561-01610-00	562-01600-00	562-01610-00

## ➤ Hei-VAP Precision

### Maximum capabilities due to integrated vacuum control

The Hei-VAP Precision provides you with the maximum range of parameters, including but not limited to, reproducible applications and fully automated processes. Even solutions with different boiling points can be identified and distilled

- Available in hand lift or motor lift configurations
- Experience the advantages of our large 4.3" color graphic display which features all parameters, integrated vacuum controller and includes programs for automated distillations
- Make your life easier by utilizing the integrated software support which leads you through the capabilities of the evaporator
- For data management Hei-VAP Precision models feature a USB interface
- Save time by configuring the unit - all connected devices will be recognized by the evaporator, which eliminates the need to configure the unit manually
- Now you can manage even the most demanding applications easily and prevent foaming, excessive bubbling or bumping
- Save time with your individualized pre-programmed parameter settings for your 30 most common applications used on a daily basis by saving them in a "Favorites" section
- Each ramp offers 20 separate steps for demanding applications
- Apply an individual name to those ramps to avoid a mix-up
- Experience the advantages of the automatic process timer which turns off your evaporator at a pre-programmed time by raising the flask on motor lift models and releasing vacuum
- Control your process individually by pre-programming vacuum gradients
- Hei-VAP Precision models feature a built-in vacuum controller as a standard



For increased safety all bath temperature adjustments can be limited

Even from a distance you will be able to monitor the numbers on the display easily

Large color graphic display for all parameters and automated programs

## ➤ Reduce your process times significantly via automated distillation programs

For automated distillation choose between these three programm opportunities:

### SET<sub>pressure</sub>

#### Program for solvent separations

This program holds a pre-set vacuum constant. During the evacuation you have the full flexibility to choose another level of vacuum by the press of a button. Optionally, the process can be predefined via programmable ramps

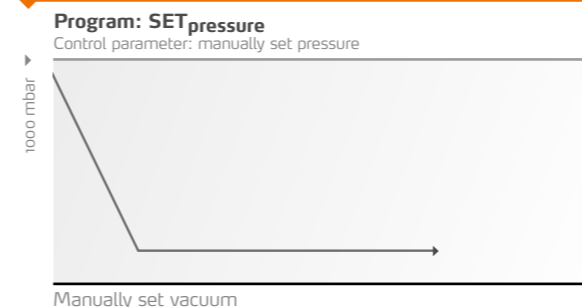

### AUTO<sub>easy</sub>

#### Supports the automatic pressure control for solvent separations

The pressure level for the first boiling point is found automatically. This program can be used with all Heidolph glassware assemblies and does not require any accessories

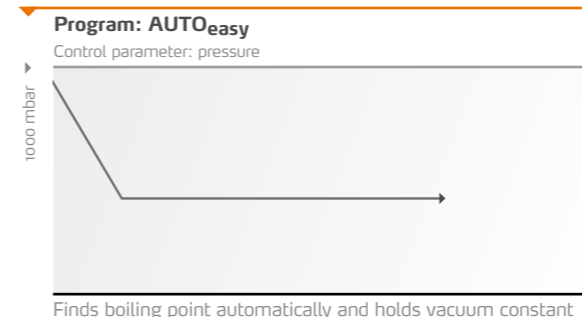

### AUTO<sub>accurate</sub>

#### Supports very precise automatic pressure control for solvent separations

This program works similar to AUTO<sub>easy</sub> but in addition is able to identify multiple boiling points automatically by reducing vacuum accordingly. Also the AUTO<sub>accurate</sub> program delivers the finest and most precise vacuum control. To take advantage of this program, the optional AUTO<sub>accurate</sub>-sensor is required. This program cannot be used on Heidolph G<sub>1</sub> and G<sub>5</sub> glassware assemblies. Leading parameter of this program is the vapor temperature

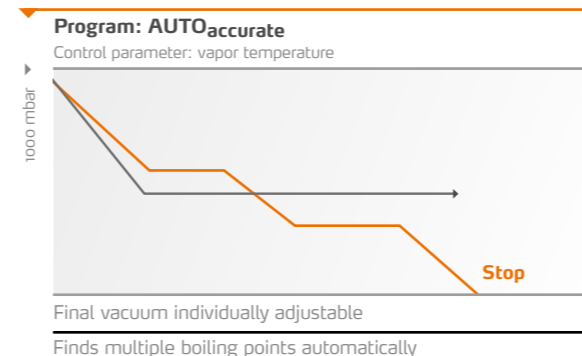

Model	Hei-VAP Precision hand lift (HL)		Hei-VAP Precision motor lift (ML)	
	standard	coated	standard	coated
G1 Diagonal	563-01100-00	563-01110-00	564-01100-00	564-01110-00
G3 Vertical	563-01300-00	563-01310-00	564-01300-00	564-01310-00
G3 XL Vertical	563-01305-00	563-01315-00	564-01305-00	564-01315-00
G5 Dry Ice Condenser	563-01500-00	563-01510-00	564-01500-00	564-01510-00
G6 Vertical for Reflux	563-01600-00	563-01610-00	564-01600-00	564-01610-00

## ➤ Glassware

- Glassware set includes one 1,000-ml evaporating flask and one 1,000-ml receiving flask
- All glassware sets are also available with transparent plastic coating for added safety<sup>1</sup>
- Evaporating flasks and vapor tubes which come with a standard NS 29/32 joint size are also available with NS 24/29 ground joints
- Also available upon request: glassware sets for Soxhlet extraction and descending condenser system
- Innovative ventilation and replenishment valves without ground joints for easy handling and grease-free operation are included
- Glassware sets G3 and G6 allow for the automated distillation program AUTO<sub>accurate</sub> on Hei-VAP Precision

### XL Condenser

#### For maximum evaporation performance

The new XL condenser with industry-leading condensing surface of 2,200 cm<sup>2</sup> achieve up to 40 % higher evaporation rates. Available in G3XL, G3B XL and G9<sup>2</sup> XL versions



### Glassware set G1

- Diagonal condenser for all standard distillations; the option with the **most affordable price**

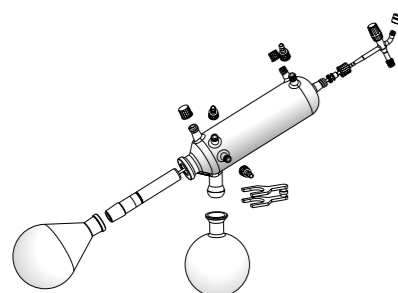

### Glassware set G5

- **Dry Ice** condenser for low-boiling solvents

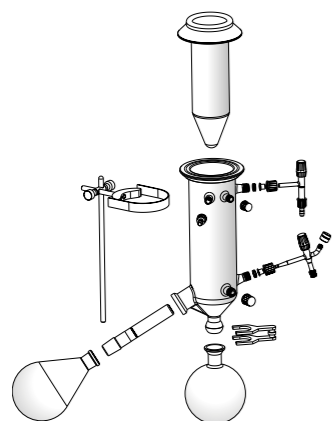

### Glassware set G3/G3 XL

- Vertical condenser for all standard distillations; the option with the smallest space requirements, also available as XL version

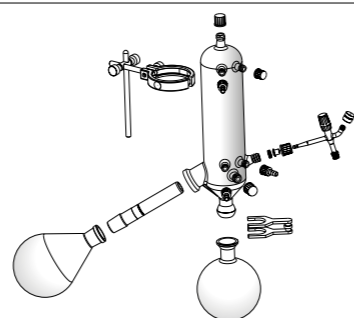

### Glassware set G6

- Vertical condenser; centerpiece with valve **for reflux distillation**

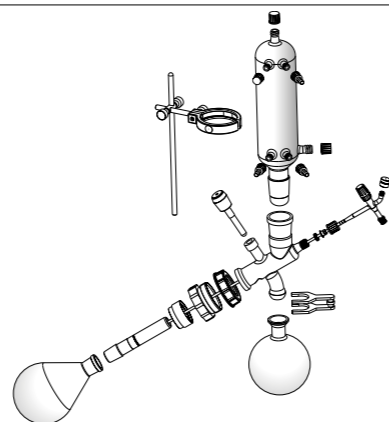

## ➤ Accessories



#### Evaporating flasks

	NS 29/32	NS 24/29
Evaporating flask* 50 ml	514-70000-00	514-70000-01
Evaporating flask 100 ml	514-71000-00	514-71000-01
Evaporating flask 250 ml	514-72000-00	514-72000-01
Evaporating flask 500 ml	514-73000-00	514-73000-01
Evaporating flask 1,000 ml	514-74000-00	514-74000-01
Evaporating flask 2,000 ml	514-75000-00	514-75000-01
Evaporating flask 3,000 ml	514-76300-00	514-76300-01
Evaporating flask 5,000 ml	514-78000-00	514-78000-03

\* Evaporating flask NS 14,5 incl. adaptor (NS 29 or NS 24)



#### Receiving flasks

	standard	coated
Receiving flask - S 35/20 100 ml	514-81000-00	514-81000-02
Receiving flask - S 35/20 250 ml	514-82000-00	514-82000-02
Receiving flask - S 35/20 500 ml	514-83000-00	514-83000-02
Receiving flask - S 35/20 1,000 ml	514-84000-00	514-84000-02
Receiving flask - S 35/20 2,000 ml	514-85000-00	514-85000-02
Receiving flask - S 35/20 3,000 ml	514-87000-00	514-87000-02



#### Powder flasks

	NS 29/32	NS 24/29
Powder flask 500 ml	514-73200-00	514-73200-01
Powder flask 1,000 ml	514-74200-00	514-74200-01
Powder flask 2,000 ml	514-75300-00	514-75300-01

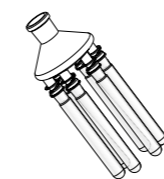

#### Spider

	NS 29/32	NS 24/29
Spider with 6 distillation sleeves NS 14,5 20 ml	15-300-005-09	15-300-005-12
Spider with 12 distillation sleeves NS 14,5 20 ml	15-300-005-10	15-300-005-13
Spider with 20 distillation sleeves NS 14,5 20 ml	15-300-005-11	15-300-005-06



#### Spider

	NS 29/32	NS 24/29
Spider with 5 flasks NS 24 50 ml	15-300-005-04	15-300-005-08
Spider with 5 flasks NS 24 100 ml	15-300-005-07	15-300-005-05



#### Evaporating cylinder

	NS 29/32	NS 24/29
Evaporating cylinder 500 ml	514-00070-00	514-00070-01
Evaporating cylinder 1,500 ml	514-00071-00	514-00071-01



#### Foam brake

	NS 29/32	NS 24/29
Foam brake with flask clamp	514-00004-00	514-00005-00

<sup>1</sup> Convenient for temperature range up to 80 °C

<sup>2</sup> for the usage of Deistimatic Bench-top

## ➤ Accessories



**Guard hood**  
P/N 569-00010-00

- Strong and transparent guard hood to protect you from implosions
- Provides easy and immediate access to flask and bath



**Guard shield**  
P/N 569-00020-00

- Strong and transparent guard shield for your protection while changing flasks
- Attached at the edge of the bath

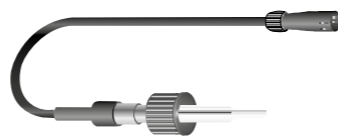

**Vapor temperature sensor**  
P/N 569-00030-00

- For Hei-VAP Advantage and Hei-VAP Precision



**AUTOaccurate-sensor**  
P/N 569-00040-00

- For Hei-VAP Precision
- Only in combination with glassware set G3 and G6



**Tubing**  
P/N 591-35000-00 (package 12 m)  
P/N 591-33000-01 (by meter)

- Tubing for vacuum and water connection. Available as package (12 meter piece incl. hose clamps) or in individual length (by meter)
- Inner diameter: 8 mm
- Outer diameter: 13 mm



**Vacuum seal**  
P/N 23-30-01-01-30 (PTFE/FKM)  
P/N 23-30-01-06-70 (PTFE/FFKM)

- Standard PTFE / FKM spare seal
- Ultra resistant PTFE / FFKM seal for applications with highly abrasive solutions



**Aqua-Stop**  
P/N 569-00500-00

The integrated valve closes automatically by turning off the evaporator. The system saves money by reducing your consumption of cooling tap water. Moreover the safety mechanism avoids flooding in your laboratory. (Only for Hei-VAP Advantage and Hei-VAP Precision)



**Spare clamping sleeve**  
P/N 23-30-01-05-31

**Spare vapor tube MS 29/32**  
P/N 514-00000-01



**Heating bath liquid**  
P/N 569-00600-00

- Heating bath liquid up to 220 °C (5 kg)

## ➤ Vacuum Pumps

Advantages of all chemical-resistant diaphragm vacuum pumps



- All components which come in contact with media are built from chemically resistant fluoropolymer
- The durable PTFE design guarantees an superior diaphragm lifespan
- The head cover and clamping disc have a stable core made of metal which offers unsurpassed long-term performance of your operational parameters
- The direct pump drive (without belt) is exceptionally quiet, creates a very low vibrational environment and reduces the need of wear and tear parts to a minimum
- The gas ballast valve has been optimized to prevent media condensing in the pump

## ➤ RPM-Regulated Vacuum Pumps

➤ **Highest distillation rates possible and reducing process time by 30 %**

➤ **Stable distillation conditions account for solvent recovery up to 99 %**

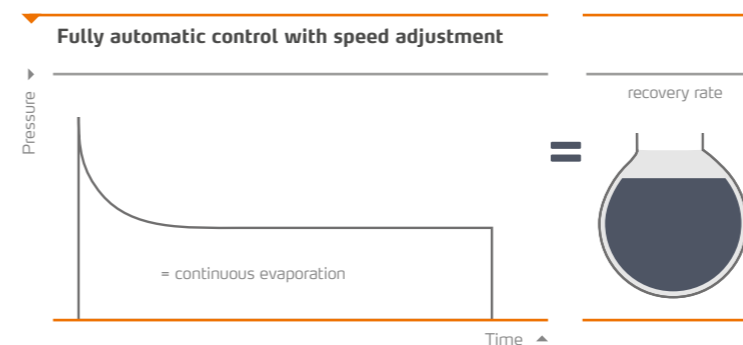

RPM regulated pumps adjust their speed individually when the required vacuum level is reached

### YOUR ADVANTAGES

- Speed adjustment stops completely if vacuum is reached and runs intermittently at very low speed to hold vacuum constant
- Increased diaphragm performance life due to periods of non-operation
- Low energy consumption due to intermittent operation
- Significant noise and vibration reduction due to periods of non-operation
- Operates without vacuum valve
- Most precise vacuum level at all times

## ➤ Valve-Regulated Vacuum Pumps

Standard vacuum pumps can be controlled manually or via valve operated vacuum controllers

### Rotavac Valve Tec



**Rotavac Valve Tec**  
P/N 591-00160-00  
**Condenser**  
P/N 591-00083-00

For all  
Hei-VAP models

Diaphragm pump		Two-stage
Suction capacity	m <sup>3</sup> /h	0.75
Ultimate vacuum	mbar	12
Combinable with a condenser		yes
Power input	Watt	80
Weight	kg	6.0
Dimensions L/W/H (without condenser)	mm	145 / 315 / 169

Specifications per unit  
Recommended for solvents with low or medium boiling points  
Vacuum can be controlled via valve operated or manual vacuum controllers

### Rotavac Valve Control



**Rotavac Valve Control**  
P/N 591-00130-00  
**Condenser**  
P/N 591-00083-00

For all  
Hei-VAP models

Diaphragm pump		Two-stage
Suction capacity	m <sup>3</sup> /h	2.0
Ultimate vacuum	mbar	7
Combinable with a condenser		yes
Power input	Watt	180
Weight	kg	12.8
Dimensions L/W/H (without condenser)	mm	195 / 245 / 310

Specifications per unit  
Suction capacity for up to three rotary evaporators at the same time  
Vacuum can be controlled via valve operated or manual vacuum controllers  
Depending on your application you can switch on and off the vacuum pump via switchbox

## ➤ RPM-Regulated Vacuum Pumps

Controllable vacuum pumps for digital regulation of the vacuum via operation panel or directly at the unit (depending on version - see below)

### Rotavac Vario Tec



**Rotavac Vario Tec**  
P/N 591-00171-00  
**Condenser**  
P/N 591-00084-00

For  
Hei-VAP Precision

Diaphragm pump		Two-stage
Suction capacity	m <sup>3</sup> /h	1.0
Ultimate vacuum	mbar	12
Combinable with a condenser		yes
Power input	Watt	160
Weight	kg	4.3
Dimensions L/W/H (without condenser)	mm	156 / 236 / 196

Specifications per unit  
Recommended for solvents with low or medium boiling points

### Rotavac Vario Control



**Rotavac Vario Control**  
P/N 591-00141-00  
**Condenser**  
P/N 591-00084-00

For  
Hei-VAP Precision

Diaphragm pump		Three-stage
Suction capacity	m <sup>3</sup> /h	1.7
Ultimate vacuum	mbar	2
Combinable with a condenser		yes
Power input	Watt	160
Weight	kg	5.4
Dimensions L/W/H (without condenser)	mm	167 / 236 / 196

Specifications per unit  
Even if the gas ballast valve is open an excellent ultimate vacuum is reached when working with easily condensable vapors. This makes distilling high boiling point solvents such as DMF or DMSO possible at low bath temperatures

### Rotavac Vario Pumping Unit



**Rotavac Vario Pumping Unit**  
P/N 591-00142-00  
**Condenser**  
P/N 591-00084-00

Fully controllable stand-alone pumping unit including vacuum controller. For Hei-VAP Value and Hei-VAP Advantage

Diaphragm pump		Three-stage
Suction capacity	m <sup>3</sup> /h	1.7
Ultimate vacuum	mbar	5
Combinable with a condenser		yes
Power input	Watt	160
Weight	kg	6.0
Dimensions L/W/H (without condenser)	mm	193 / 263 / 299

Specifications per unit  
Precise vacuum control avoids bumping and eliminates foaming of your evaporation solution  
Due to automatic vacuum supply to the process parameters you have more time for important laboratory activities

## ➤ Vacuum Accessories

### Switchbox

Connect up to three rotary evaporators to one vacuum pump



#### Switchbox

P/N 569-00400-00

- Connect up to three rotary evaporators to one pump and control vacuum individually
- Pump switches off automatically at required vacuum
- Reduces energy consumption of pump
- Increases performance life of the pump due to a complete switch-off if vacuum is reached
- Vacuum valve and non-return valve are required for every evaporator if you work with different pressures at the same time
- Delivery includes three non-return valves
- Designed for Hei-VAP Precision
- Weight: 0.6 kg
- Dimensions: L80 / W160 / H45 mm

### Manual vacuum controller

For Hei-VAP Value and Hei-VAP Advantage



#### Manual vacuum controller

P/N 591-26000-00

- Control your house vacuum or any other vacuum source
- Pressure range from 0 to 1,020 mbar
- Scaling on display in steps of 50 mbar
- Connection for tubes with 8 mm inner diameter
- Support rod included
- A vacuum valve is not required
- Dimensions: L80 / W80 / H150 mm

### Vacuum valve

Required to control vacuum for Hei-VAP Precision models with valve-regulated pumps



#### Vacuum valve

P/N 569-00060-00

- External attachment design for easy cleaning
- Can be combined with the Woulff Bottle to one unit
- Not required if you utilize a Manual vacuum controller

### Woulff bottle

P/N 569-00070-00

- Additional recovery of solvent to protect vacuum valve and vacuum pump
- Compatible with all Hei-VAP configurations
- Direct connection to the vacuum valve is possible
- Features connection to vacuum controller
- Volume of 250 ml

## ➤ Chillers

### RotaChill Large

Highest cooling capacity



#### RotaChill Large

P/N 591-00240-00

- Highest cooling capacity for any application
- Temperature range from -20 °C to +40 °C
- Temperature control accuracy of ±0.1 °C
- Digital display for temperature setting and reading out actual temperature
- Cooling capacity at +20 °C: 1,290 W
- Footprint of chiller: L607 / W254 / H483 mm

### Rotacool Mini

Ideal for standard applications



#### Rotacool Mini

P/N 591-00210-00

- Chiller for all standard applications
- Temperature range from -10 °C to +40 °C
- Temperature control accuracy of ±1 °C
- Digital display for temperature settings and reading out actual temperature
- Cooling capacity at +20 °C: 580 W
- Footprint of chiller: L360 / W310 / H520 mm

### RotaChill Small

The affordable model



#### RotaChill Small

P/N 591-00220-00

- Temperature range from 0 °C to +100 °C
- Precise temperature control accuracy of ±0.2 °C
- The RotaChill Small should be placed directly besides the evaporator to ensure a sufficient pump performance
- Footprint of chiller: L450 / W210 / H570 mm

		RotaChill Large	Rotacool Mini	RotaChill Small
Temperature range	[°C]	-20 to +40	-10 to +40	0 to +100
Coolant volume	[L]	2.7	3	6
Cooling capacity* at: +20 °C	[W]	1,290	580	200
	0 °C	750	370	140
	-10 °C	-	80	-
	-20 °C	260	-	-

\* at 20 °C ambient temperature

## Equipment Combinations

With the Hei-VAP series you can easily assemble your individual laboratory equipment - exactly to your requirements.

Please refer to the overview by Hei-VAP units for the possible configurations or contact us - we are happy to be at your service and will advise you in detail.

### Example configuration

#### Rotary Evaporator



Hei-VAP Advantage

#### Vacuum source



Rotovac Vario Pumping Unit



#### Accessories



- Vacuum controller
- Vapor temperature sensor (all glassware sets)
- Vacuum valve

- included** > included in pumping unit, no further configuration required
- optional** > optional available as accessory
- not required** > not required due to rpm regulation

As an aid to decision-making we have created different packages for you, from basic equipment up to automatic distillation with RPM-regulated vacuum pumps - for details see the following pages.

## Overview of Hei-VAP units

### Rotary Evaporator



Hei-VAP Value / Hei-VAP Value Digital

### Vacuum source

- Rotovac Vario Pumping Unit
  - included** >
  - not required** >
- Rotovac Valve Control
- Rotovac Valve Tec
- House vacuum

### Accessories

- Vacuum controller
- Vacuum valve
- Manual vacuum controller



Hei-VAP Advantage

- Rotovac Vario Pumping Unit
  - included** >
  - optional** >
  - not required** >
- Rotovac Valve Control
- Rotovac Valve Tec
- House vacuum

- Vacuum controller
- Vapor temperature sensor (all glassware sets)
- Vacuum valve
- Manual vacuum controller
- Vapor temperature sensor (all glassware sets)



Hei-VAP Precision

- Rotovac Valve Control
  - included** >
  - required** >
- Rotovac Valve Tec
- House vacuum

- Vacuum controller
- Vacuum valve
- Autoaccurate-sensor (glassware G3/G6 only)
- Vapor temperature sensor (all glassware sets)

- Rotovac Vario Control
  - included** >
  - not required** >
- Rotovac Vario Tec

- Vacuum controller
- Vacuum valve
- Autoaccurate-sensor (glassware G3/G6 only)
- Vapor temperature sensor (all glassware sets)



Rotovac Valve Control with condenser   Rotovac Valve Tec with condenser   Rotovac Vario Control with condenser   Rotovac Vario Tec with condenser   Rotovac Vario Pumping Unit with condenser   Manual vacuum controller   Vacuum valve with Wouff bottle   AUTOaccurate-sensor   Vapor temperature sensor



## ➤ Hei-VAP Packages



**Hei-VAP Silver 4 Package**  
P/N 560-91302-00



**Hei-VAP Gold 3 Package**  
P/N 562-91307-00



**Hei-VAP Platinum 2 Package**  
P/N 563-51310-00



**Hei-VAP Platinum 5 Package**  
P/N 564-31318-00

### Hei-VAP Silver Packages

Standard equipment for your lab

#### Hei-VAP Silver 4 Package

P/N 560-91302-00

Hei-VAP Value Digital with hand lift and vertical glassware set G3

- Vacuum pump Rotavac Valve Tec
- Manual vacuum controller
- Tube set

#### Hei-VAP Silver 5 Package

P/N 560-81312-00

Hei-VAP Value Digital with hand lift and coated vertical glassware set G3B

- Vacuum pump Rotavac Valve Control
- Manual vacuum controller
- Tube set

#### Hei-VAP Silver 6 Package

P/N 560-91309-20

Hei-VAP Value Digital with hand lift and vertical glassware set G3

- Vacuum pump Rotavac Valve Tec
- Manual vacuum controller
- Chiller RotaChill Small
- Tube set

### Hei-VAP Gold Packages

For standard distillations with vacuum control

#### Hei-VAP Gold 1 Package

P/N 561-41300-00

- Hei-VAP Advantage with hand lift and vertical glassware set G3
- Vapor temperature sensor
- Vacuum pump Rotavac Valve Tec
- Manual vacuum controller
- Tube set

#### Hei-VAP Gold 2 Package

P/N 562-11310-00

- Hei-VAP Advantage with motor lift and coated vertical glassware set G3B
- Vapor temperature sensor
- Vacuum pump Rotavac Vario Pumping Unit
- Tube set

#### Hei-VAP Gold 3 Package

P/N 562-91307-00

- Hei-VAP Advantage with motor lift and vertical glassware set G3
- Vacuum pump Rotavac Valve Tec
- Manual vacuum controller
- Chiller Rotacool Mini
- Tube set

#### Hei-VAP Gold 4 Package

P/N 564-61310-00

- Hei-VAP Precision with motor lift and vertical glassware set G3B
- Vacuum pump Rotavac Valve Tec with condenser
- Vacuum valve
- Tube set

### Hei-VAP Platinum Packages

Automatic distillations with Hei-VAP Precision hand lift models and valve-regulated vacuum pumps

#### Hei-VAP Platinum 1 Package

P/N 563-61300-00

- Hei-VAP Precision with hand lift and vertical glassware set G3
- Vapor temperature sensor
- Vacuum valve
- Vacuum pump Rotavac Valve Tec with condenser
- Tube set

#### Hei-VAP Platinum 2 Package

P/N 563-51310-00

- Hei-VAP Precision with hand lift and coated vertical glassware set G3B
- AUTOaccurate-sensor
- Vacuum valve
- Vacuum pump Rotavac Valve Control with condenser
- Tube set

### Hei-VAP Safety Upgrade

For highest safety

#### Hei-VAP Safety Upgrade

P/N 569-00311-00

Additional guard hood and coating of glassware for your Hei-VAP Package



### Hei-VAP Platinum Packages

Automatic distillations with Hei-VAP Precision motor lift models and RPM-regulated vacuum pumps

#### Hei-VAP Platinum 3 Package

P/N 564-21300-00

- Hei-VAP Precision with motor lift and vertical glassware set G3
- AUTOaccurate-sensor
- Vacuum pump Rotavac Vario Tec with condenser
- Woulff bottle
- Tube set

#### Hei-VAP Platinum 4 Package

P/N 564-31310-00

- Hei-VAP Precision with motor lift and coated vertical glassware set G3B
- AUTOaccurate-sensor
- Vacuum pump Rotavac Vario Control with condenser
- Woulff bottle
- Tube set

#### Hei-VAP Platinum 5 Package

P/N 564-31318-00

- Hei-VAP Precision with motor lift and coated vertical glassware set G3B
- AUTOaccurate-sensor
- Vacuum pump Rotavac Vario Control with condenser
- Woulff bottle
- Chiller RotaChill Large
- Tube set

#### Hei-VAP Platinum 5 XL Package

P/N 564-31319-00

- Hei-VAP Precision with motor lift and coated vertical glassware set G3B XL
- AUTOaccurate-sensor
- Vacuum pump Rotavac Vario Control with condenser
- Woulff bottle
- Chiller RotaChill Large
- Tube set

## Technical Specifications - Rotary Evaporators

Model	Hei-VAP Value (HL) / Value Digital (HL)	Hei-VAP Advantage (HL)	Hei-VAP Advantage (ML)	Hei-VAP Precision (HL)	Hei-VAP Precision (ML)
Hand / Motor lift	hand lift	hand lift	motor lift	hand lift	motor lift
Height adjustment speed	manual	manual	30 mm/s	manual	30 mm/s
Height adjustment (mm)	155	155	155	155	155
Rotation speed (rpm)	10 – 280	10 – 280	10 – 280	10 – 280	10 – 280
Rotation speed setting	scale	3.5" LCD display	3.5" LCD display	4.3" LCD color graphic display	4.3" LCD color graphic display
Drive		brushless DC motor with electronic speed control			
Heating capacity (W)	1,300	1,300	1,300	1,300	1,300
Temp. range heating bath (°C)	20 – 210	20 – 210	20 – 210	20 – 210	20 – 210
Temperature accuracy bath (°C)	±1	±1	±1	±1	±1
Overheat protection bath (°C)		cut-off at 5 °C over set temperature via separate Pt 1000			
Bath temperature setting****	scale / digital	3.5" LCD display	3.5" LCD display	4.3" LCD color graphic display	4.3" LCD color graphic display
Heating bath temperature control	electronic / digital	electronic / digital	electronic / digital	electronic / digital	electronic / digital
Secondary overtemp. cut-off (°C)	250	250	250	250	250
Material heating bath	stainless steel AISI 316L	stainless steel AISI 316L	stainless steel AISI 316L	stainless steel AISI 316L	stainless steel AISI 316L
Diameter heating bath (mm)	255	255	255	255	255
Volume heating bath (L)	4.5	4.5	4.5	4.5	4.5
Display vapor temperature required accessories	no	yes vapor temperature sensor	yes vapor temperature sensor	yes vapor temperature sensor	yes vapor temperature sensor
Integrated vacuum controller	no	no	no	yes	yes
Timer	no	yes	yes	yes	yes
Vacuum program SET <sub>pressure</sub> **	no	no	no	yes	yes
Vacuum program AUTO <sub>easy</sub> **	no	no	no	yes	yes
Vacuum program AUTO <sub>accurate</sub> ** requires AUTO <sub>accurate</sub> -sensor	no	no	no	yes	yes
Remote control function					
- Lift	no	no	yes	no	yes
- Start rotation	yes	yes	yes	yes	yes
- Start vacuum	no	no	no	yes	yes
- Start heating bath	yes	yes	yes	yes	yes
Programmable ramps	no	no	no	yes	yes
Supply power (W)	1,400	1,400	1,400	1,400	1,400
Weight (w/o glassware assembly) (kg)	16	16	16	17	17
Dimensions with glassware set G3 (mm) Width on extended heating bath (l x w x h)	477 x max. 739 x 845	477 x max. 739 x 845	407 x max. 739 x 845	523 x max. 739 x 845	453 x max. 739 x 845
Dimensions with glassware set G3 XL (mm) Width on extended heating bath (l x w x h)	477 x max. 739 x 920	477 x max. 739 x 920	407 x max. 739 x 920	523 x max. 739 x 920	453 x max. 739 x 920
Protection class*** (DIN EN 60529)	IP 20	IP 20	IP 20	IP 20	IP 20
Permissible ambient conditions	5 – 31 °C at 80 % rel. humidity 32 – 40 °C decreasing linearly up to max. 50 % rel. humidity	5 – 31 °C at 80 % rel. humidity 32 – 40 °C decreasing linearly up to max. 50 % rel. humidity	5 – 31 °C at 80 % rel. humidity 32 – 40 °C decreasing linearly up to max. 50 % rel. humidity	5 – 31 °C at 80 % rel. humidity 32 – 40 °C decreasing linearly up to max. 50 % rel. humidity	5 – 31 °C at 80 % rel. humidity 32 – 40 °C decreasing linearly up to max. 50 % rel. humidity
Condensing surface (cm <sup>2</sup> )	1,400	1,400	1,400	1,400	1,400
Condensing surface XL Condenser (cm <sup>2</sup> )	2,200	2,200	2,200	2,200	2,200

Rate of evaporation* (L/h)	Toluene	Acetone	Ethanol	Isopropanol (IPA)	Water
G3 Vertical	6.5	6.0	2.5	4.0	1.4
G3 XL Vertical	8.5	7.5	3.5	4.9	1.4
Improvement with XL condenser (%)	31	25	40	23	system limit reached with 1.4 L/h

\* With maximum condenser efficiency  
\*\* Only in combination with vacuum systems

\*\*\* IP 67 cable connection on heating bath  
\*\*\*\* Hei-VAP Value Digital: digital display

Standard supply voltage: 230 V - other voltages upon request, please specify for order

# Certificate

To confirm the ability for  
continuous operation  
of the Hei-VAP series Rotary Evaporators

Hei-VAP series Rotary Evaporators feature overtemperature safety circuits according to DIN EN 61010-1:2001 and DIN EN 61010-2-010:2014 and therefore is designed for continuous operation.

This statement is made under the precondition that all units are operated in accordance with the operation manual and in accordance with good practice standards for safety in laboratories, rules for accident preventions, and compliance with directions on hazardous materials.

Schwabach, January 2018



Stefan Peters  
Research and Development Manager



Marcell Sarré  
Quality Manager

# Industrial Evaporation



## Hei-VAP Industrial Large-Scale Rotary Evaporators

Leading Safety Standards

Superior Ease of Use

Reduced Cost of Ownership



Do you require safe and quick flask removal by one person with industry leading safety standards?

## Industrial Evaporation

With the Hei-VAP Industrial series you are always on the safe side with the safety enclosure protecting you and your glassware! You can operate the Hei-VAP Industrial just by yourself, change flasks in seconds and operate the unit with ease.



## Leading Safety Standards

- The **EASY LOCK** flask attachment allows for safe flask change
- An **emergency off button** brings the entire unit to a complete stop
- To promote a safe use of the Hei-VAP Industrial evaporator the interface panel not only has all parameters for operation but also **5 key safety functions that require operator action prior to resuming process**
- Features **water level regulation system** to prevent water spilling over bath and potentially flooding your lab
- Safety sensor **stops rotation if bath guard hood is opened** during operation thus providing user safety
- A **temperature sensor** powers off the bath in case of any uncontrolled heat-up
- To effectively prevent accidents while monitoring parameters the speed, bath temperature and vacuum setting must be confirmed on **separate on/off buttons in order to start operation**
- **Automatic safety cut-off** in an **overpressure situation** caused by glassware breakage or defective vacuum circuit
- Receiving cassette system **protects glassware** while providing superior flask support. Easy access to receiving cassettes via two latching high-impact transparent PMMA doors
- **Ultimate safety** is provided with the Hei-VAP Industrial model which comes standard with: a guard hood consisting of a metal frame and safety glass completely covering the bath. This prevents any operator contact with steam, splashing bath fluid and splinters of glass in case of implosion
- **Excellent user safety** is achieved by a transparent high impact PMMA door on a metal condenser housing covering the main glassware assembly





## Superior Ease of Use

- **Intuitive touch screen control** for easy operation
- Touch screen with glass surface for **chemical resistance** and **easy cleaning**
- **EASY LOCK** flask attachment for **quick and easy flask changes**
- Illuminated bath and evaporation flask allows for **superior visual control**
- Integrated heating coils guarantee the most **convenient and fastest cleaning of the bath**
- Receiver cassettes guard against glassware breakage while providing a self-standing flask support and **quick removal** of receiving vessels
- Save time with up to 250 **pre-programmed steps** of up to 999 process ramps
- Unique self-aligning flask support system allows for immediate **one-person operation**
- Reduce your process times by using the exclusive AUTOaccurate program which automates your distillation using a vapor temperature system that **takes the guesswork out** of finding the correct vacuum setting every time
- No hassle and safety concern due to low fluid levels: **self-filling water bath** takes the worry out of running dry
- Receiving flasks feature **reinforced bottom drain valves** as standard and are protected by cassettes
- To prevent steam from building up within the guard hood, two strong blowers effectively ventilate the entire area to give you a **clear view of the evaporating flask**
- Now you can manage even the **most demanding applications** easily and eliminate foaming, excessive bubbling or bumping of solutions
- The **automatic process timer** turns off your evaporation at a pre-programmed time
- The optional automatic module Distimatic Industrial allows for **continuous and unattended automatic operations**
- Optional Base Cart provides you with a **fully-maneuverable rotary evaporator** while offering a storage space for vacuum pump, glassware, solvents or accessories

## Reduced Cost of Ownership

- **Universal heating bath** for water or other bath fluids allows for temperature settings up to 180 °C
- Utilize the **pre-heating option** for your bath and **start your application without any loss of time**
- The water bath refill system allows you to step away from your evaporator at any moment and **reduce your supervision responsibility to zero** for baths that run dry or overheat
- **No hidden cost:** all components to control vacuum are included as a standard. This includes vacuum valve, vacuum controller, vacuum sensor and vapor temperature sensor
- AUTOaccurate-evaporations drive your solution to a variable quantity or dryness, then shut off vacuum, heating bath and rotation, and ventilates the system to give you semi-automated capabilities at **significant cost savings**
- **Spend your working hours more effectively** on other challenges which require your attention and evaporate large quantities continuously with the automatic module Distimatic Industrial
- Maximize your initial investment significantly: the automatic module Distimatic Industrial is an **affordable and more flexible alternative** to common 50 or 100-liter evaporators
- **Increased throughput at reduced energy consumption** due to an industry leading leak-proof vacuum seal:
  - final pressure below 1 mbar
  - pressure increase below 1 mbar/min

## Hei-VAP Industrial control panel



## Two Programs for Process Control

### SET<sub>pressure</sub>

#### Program for solvent separations

- This program holds a set vacuum constant and uses a hysteresis
- Optionally, the process can be predefined via programmable ramps

Program: SET<sub>pressure</sub>  
Control parameter: manually set pressure

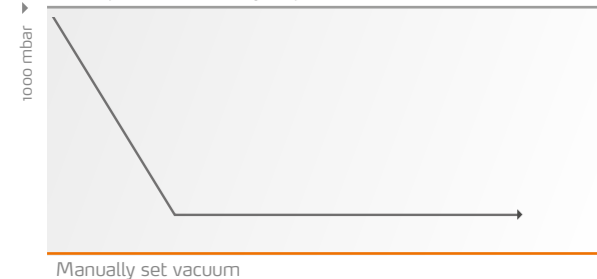

### AUTO<sub>accurate</sub>

#### Supports very precise automatic pressure control for solvent evaporation and separations

- This program identifies multiple boiling points automatically by reducing vacuum

Program: AUTO<sub>accurate</sub>  
Control parameter: vapor temperature

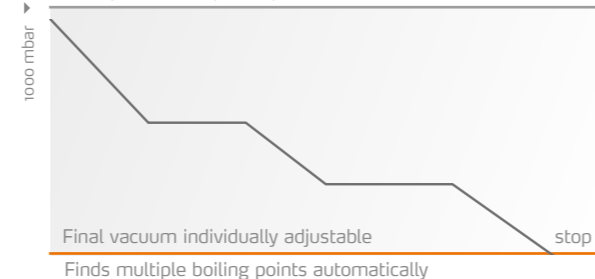

# Industrial Evaporation



Leading Safety Standards

Superior Ease of Use

Reduced Cost of Ownership

The average operational **lifespan of 10 years** is backed by a **3 year warranty** and makes your purchase a worthwhile investment.

Illuminated bath and evaporation flask allows for superior **visual control**

The **EASY LOCK** flask attachment allows for single-user safe flask exchange

**Excellent user safety:** condenser and receiving flasks are protected by high-impact transparent PMMA doors

Receiver cassettes **guard against glassware breakage** while providing a self-standing support

A guard hood consisting of a metal frame and safety glass covers the bath completely while providing **clear visible monitoring**

**Increased throughput at reduced energy consumption** due to an industry leading vacuum leakproof

Features **level regulation system** to prevent from spilling over and potential floods in lab

Unique self-aligning flask support system allows for immediate **"one-person operation"**

Non-visible heating coils guarantee the most convenient and **fastest cleaning of the bath**

**Intuitive touch screen** control for ease of operation

Unit **powers off all relevant functions** in case of a bath overtemperature situation, overpressure and glassware breakage

**No hassle or safety concerns due to low bath fluid levels:** the self-filling water bath takes the worry out of running dry

**Automatic module Distimatic Industrial - For batch and continuous evaporation without limits** - an affordable and more flexible alternative to common 50 or 100-liter evaporators

Save time with up to 250 pre-programmed profiles of **up to 999 process gradients**



## ➤ Hei-VAP Industrial

### Highest safety and integrated vacuum control capabilities

Includes leading safety standards and features for superior ease of use and reduced cost of ownership, plus:



Excellent user safety with high-impact transparent PMMA door

Non-fogging safety glass and metal frame guard hood provides excellent user protection

The evaporation flask is illuminated during operation for increased visibility

Certification according to GMP available for this model: validation for installation (IQ) and operating qualification (OQ)

Universal heating bath accommodates water or other bath fluids allowing for temperature settings up to 180 °C

Optional Base Cart is fully-maneuverable with removable panels for storage of vacuum pump, glassware, solvents or accessories

Large touch screen control panel with illuminated displays for all process parameters, programmable ramps as described on page 42

Receiver cassettes and additional PMMA door housing protect against threat of glassware breakage

Comes as standard with integrated refill water system, spillover prevention and a release valve at the bottom

Hei-VAP Industrial with glassware set RC (without Base Cart)  
P/N 518-12100-00

## ➤ Glassware – Hei-VAP Industrial

### Glassware Shorty R

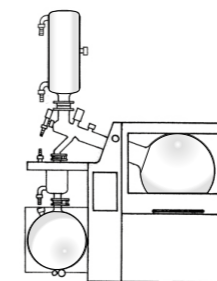

- Identical to glassware R, but features a condenser that is 320 mm shorter
- Distillation capacity remains the same. This assembly is ideal in laboratories for hood applications or where height is restricted

### Glassware Shorty RC

- Identical to glassware assembly Shorty R, but features two receiving flasks

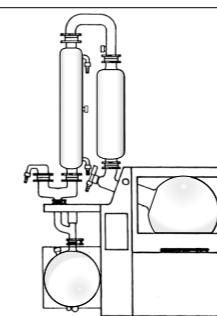

### Glassware A

- This glassware assembly includes one descending condenser, one expansion vessel, one 20-l evaporating flask, one 10-l receiving flask and is recommended **for solvents that tend to splash and foam**

### Glassware AC

- Identical to glassware assembly A, but features two receiving flasks

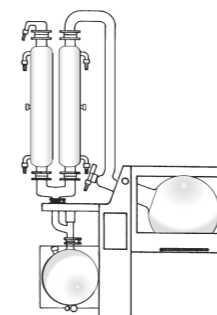

### Glassware A1

- This glassware assembly includes one ascending, one descending condenser, one ascent pipe, one 20-l evaporating flask and one 10-l receiving flask
- **For low-boiling solvents and highest recovery rates**

### Glassware A1C

- Identical to glassware assembly A1, but features two receiving flasks

### Glassware R

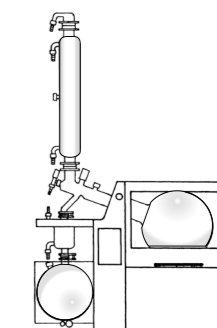

- This glassware assembly includes one ascending condenser, one 20-l evaporating flask, one 10-l receiving flask and is recommended **for all standard distillations**

### Glassware RC

- Identical to glassware assembly R, but features two receiving flasks

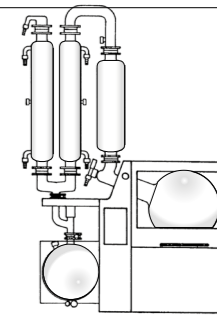

### Glassware A2

- This glassware assembly includes one ascending, one descending condenser and one expansion vessel, one 20-l evaporating flask, one 10-l receiving flask
- **For low-boiling solvents and highest recovery rates**

### Glassware A2C

- Identical to glassware assembly A2, but features two receiving flasks

### Glassware K

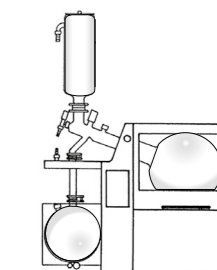

- Condensate trap **for low-boiling solvents; cooling by dry-ice**
- Comes with one 20-l evaporating flask and one 10-l receiving flask

### Glassware KC

- Identical to glassware assembly K, but features two receiving flasks

## ➤ Vacuum Pump

### Valve-regulated vacuum pump Rotovac 20

P/N 591-07210-00

Includes secondary condenser and air intake separation vessel

This vacuum system can be applied in many different fields in order to evacuate, evaporate and pump out gases and vapors. Thanks to the emission condenser it is possible to achieve a chemical recovery of almost 100%

- Excellent compatibility with chemicals and condensate
- Excellent ultimate vacuum of 2 mbar
- Very quiet and very low vibration
- Very high suction capacity of 3.0 m<sup>3</sup>/h
- Weight: 19.9 kg
- Dimensions: W350 / D275 / H495 mm



## ➤ Accessories - Hei-VAP Industrial



### Evaporating flasks

Evaporating flask 6 l

P/N 15-300-003-23

Evaporating flask 10 l

P/N 15-300-003-22

Evaporating flask 20 l

(Included as a standard)

P/N 15-300-003-21



### Powder flasks

Powder flask 10 l

P/N 15-300-003-24

Powder flask 20 l

P/N 15-300-003-25

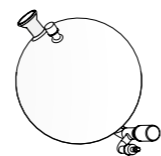

### Receiving flask

P/N 15-300-004-11

With drain valves, 10 l  
(Included as a standard for all Hei-VAP Industrial models)

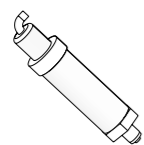

### Vacuum sensor

P/N 591-21000-00

(Included as a standard for all Hei-VAP Industrial models)

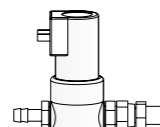

### Vacuum valve

P/N 591-20000-00

(Included as a standard for all Hei-VAP Industrial models)



### Tubing

P/N 591-34000-00 (package 16 m)

P/N 591-33000-01 (by meter)

Tubing for vacuum and water connection. Available as package (16 meter piece incl. hose clamps) or in individual length (by meter)



### Vapor temperature sensor

P/N 14-014-003-06

(Included as a standard for all Hei-VAP Industrial models)

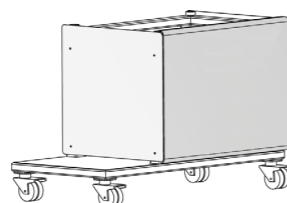

### Base Cart

P/N 591-23000-00

For all Hei-VAP Industrial models



### Heating bath liquid

P/N 569-00600-00

Heating bath liquid up to 220 °C (5 kg)

## ➤ Part Numbers – Hei-VAP Industrial

### Hei-VAP Industrial

#### Without Base Cart

#### Glassware

R	518-11100-00
Shorty R	518-18100-00
RC	518-12100-00
Shorty RC	518-19100-00
A	518-13100-00
AC	518-15100-00
A1	518-14102-00
A1C	518-16102-00
A2	518-14100-00
A2C	518-16100-00
K	518-18102-00
KC	518-19102-00



Limited budgets?  
Hei-VAP Industrial B >>>

### Hei-VAP Industrial B

As shown above (Hei-VAP Industrial) - without:

- Metal frame and safety glass guard hood covering the bath
- High-impact PMMA door covering the glassware assembly
- High-impact PMMA latching door which cover the receiving flask cassettes

#### Without Base Cart

#### Glassware

R	518-21100-00
Shorty R	518-28100-00
RC	518-22100-00
Shorty RC	518-29100-00
A	518-23100-00
AC	518-25100-00
A1	518-24102-00
A1C	518-26102-00
A2	518-24100-00
A2C	518-26100-00
K	518-28102-00
KC	518-29102-00



## Technical Specifications - Large-Scale Rotary Evaporators

Model	Hei-VAP Industrial
Rotation speed (rpm)	6 - 160
Rotation speed setting	digital
Heating bath lift	motor lift
Height adjustment speed (mm/s)	45
Height adjustment (mm)	180
Drive	EC-motor
Heating capacity (W)	4,000
Temperature range heating bath (°C)	20 - 180
Temperature accuracy (°C)	±1
Overheat cut-off protection (°C)	110 (H <sub>2</sub> O) / 210 (oil)
Bath temperature setting	digital
Automatic heating bath control	micro processor
Material heating bath	V4A (1.4404)
Diameter heating bath (mm)	400
Volume heating bath (l)	24 (H <sub>2</sub> O) / 22 (oil)
Level regulation of water bath	automatically due to level sensor and refill function
Display vapor temperature (required accessories)	digital temperature sensor
Indicating range vapor temperature sensor (°C)	0 - 200 (accuracy 0.1 °C)

Model	Hei-VAP Industrial
Vacuum controller	yes
Timer	yes
Vacuum control program SET <sub>pressure</sub> **	yes
Vacuum control program AUTO <sub>accurate</sub> ** requires AUTO <sub>accurate</sub> -sensor	yes
Programmable ramps	yes
Supply power (W)	4,600
Weight (without glass assembly) (kg)	approx. 120
Dimensions (l x w x h) (mm)	970 x 690 x 1,600
Protection class (DIN EN 60529)	IP 20
Permissible ambient conditions	5 - 31 °C at 80 % rel. humidity 32 - 40 °C decreasing linearly up to max. 50 % rel. humidity
Rate of evaporation (L/h) at 40 °C * temperature difference	
- Toluene	26.0
- Acetone	25.9
- Ethanol	12.9
- Water	4.7
Maximum condensing surface (m <sup>2</sup> )	1.2

\*  $\Delta T$  = difference between heating bath temperature and boiling temperature

\*\* Only in combination with vacuum systems

Standard supply voltage: 400 V three-phase current - other voltages upon request, please specify for order

# Certificate

To confirm the ability for  
continuous operation  
of the Hei-VAP Industrial series Large-Scale Rotary Evaporators

The Hei-VAP Industrial series Large-Scale Rotary Evaporators feature overtemperature safety circuits according to DIN EN 61010-1:2001 and DIN EN 61010-2-010:2014 and therefore is designed for continuous operation.

This statement is made under the precondition that all units are operated in accordance with the operation manual and in accordance with good practice standards for safety in laboratories, rules for accident preventions, and compliance with directions on hazardous materials.

Schwabach, January 2018



Stefan Peters  
Research and Development Manager



Marcell Sarré  
Quality Manager

# Automatic 24/7 Evaporation



## Hei-VOLUME Automatic Modules

Leading Safety Standards

Superior Ease of Use

Reduced Cost of Ownership

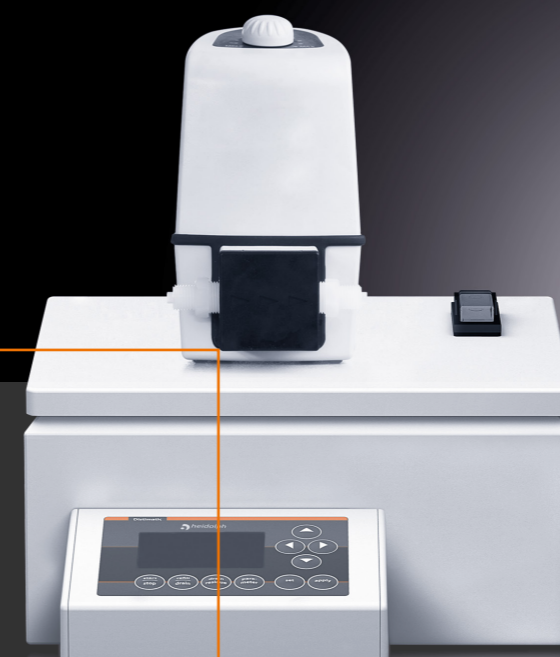



Do you require a system to evaporate unlimited volumes in a continuous and unattended process 24 hours a day/7 days a week?

## Automatic 24/7 Evaporation

Save time by using the automatic module Distimatic and distill large volumes in a continuous and unattended manner overnight and during the weekend!



## General

- **Automatic refill** of the evaporation flask with the solvent mixture according to your settings. **Continuous automatic discharge of condensate**
- The **worldwide unique automatic residue drainage** offers unattended distillation for days
- The automatic module is **compatible with all bench-top and large-scale evaporators** from Heidolph
- The storage and the collecting tank can be **replaced during the process**

## Leading Safety Standards

- The complete system is sensor-controlled and **turns off the automatic module as well as all connected equipment completely in case of an emergency**
- The system **can be placed under a fume hood** which ensures the highest safety level for the operator
- An easily accessible emergency-button allows you to **stop the process immediately** by the operator

## Superior Ease of Use

- Take advantage of the wide range of possibilities to **adjust the settings according to your individual needs**
- The **worldwide unique automatic residue drainage** offers a wide range of new possibilities for **automatic, continuous and unattended distillation**
- The process can be **terminated automatically** after evaporation is completed or manually at any time by the operator
- Integrated plug connectors enable you to connect and to **control** also peripheral equipment **from a central point**

## Reduced Cost of Ownership

- **Affordable alternative to common 50 or 100 liter evaporators**
- **Increase your efficiency** - the fully automatic process avoids the need of visual control and gives you time to focus on other tasks
- **Reduce your investments** by using your existing equipment - the automatic module is compatible to all rotary evaporators from Heidolph
- The unattended and continuous reconditioning of solvent **avoids any bottlenecks** of availability of solvents and reduce your investments in this way

## ➤ The smart way to process large quantities automatically

- The automatic module Distimatic is available for Hei-VAP rotary evaporators (Distimatic Bench-top) and Hei-VAP Industrial large-scale rotary evaporators (Distimatic Industrial)
- For distillation select between these two modes:
  - **Sensor-Mode:** Refill and drainage are automatically sensor-controlled
  - **Time-Mode:** All parameters controlled by individually pre-programmed automatic time intervals
- Process rates with bench-top evaporators for the most common solvents are:
  - **Water: 1.4 l/h**
  - **Acetone: 6.0 l/h**
  - **Toluene: 6.5 l/h**
  - **Ethanol: 2.5 l/h**
- Increased process rates with Hei-VAP Industrial large-scale evaporators, for example:
  - **Water: 4.5 l/h**
  - **Acetone: 25.0 l/h**
- Both modes are completed in an automated and unattended process of solvent separations of nearly 100 %
- Degree of concentration for final product can be determined to rule out dehydration, crystallisation and formation of powder
- Bumping is eliminated by continuously feeding small volumes

## ➤ For distillation select between these two modes:



Sensor-Mode:

Time-Mode:

Refill and drainage are automatically sensor-controlled

- A sensor detects the fill-level inside the evaporation flask
- The desired/requested fill-level can be set individually
- Flask refill is achieved via valve control and under system pressure
- A sensor monitors the quantity of the solvent mixture and powers off the unit once it is completely processed

All parameters controlled by individually pre-programmed automatic time intervals

- The desired/requested fill-level can be set individually
- Flask refill is achieved via valve control and under system pressure according to pre-programmed cycles
- The process is powered off once the pre-programmed number of cycles have expired

# Automated 24/7 Evaporation

Leading Safety Standards

Superior Ease of Use

Reduced Cost of Ownership

The average operational **lifespan of 10 years** is backed by a **3 year warranty** and makes your purchase a worthwhile investment.

Automated in unattended distillation in **two different modes**

**Automatic refill** of the evaporation flask and continuous **automatic discharge of condensate**

**Automatic drainage of residue:** residue in the evaporation flask will be drained off

**Compatible** with all Hei-VAP rotary evaporators (Distimatic Bench-top) and Hei-VAP Industrial large-scale rotary evaporators (Distimatic Industrial)

The automatic module Distimatic Bench-top can be **used in common fume hoods** due to the space saving design

Applications are completed in an automated and unattended process of **solvent separations of nearly 100 %**

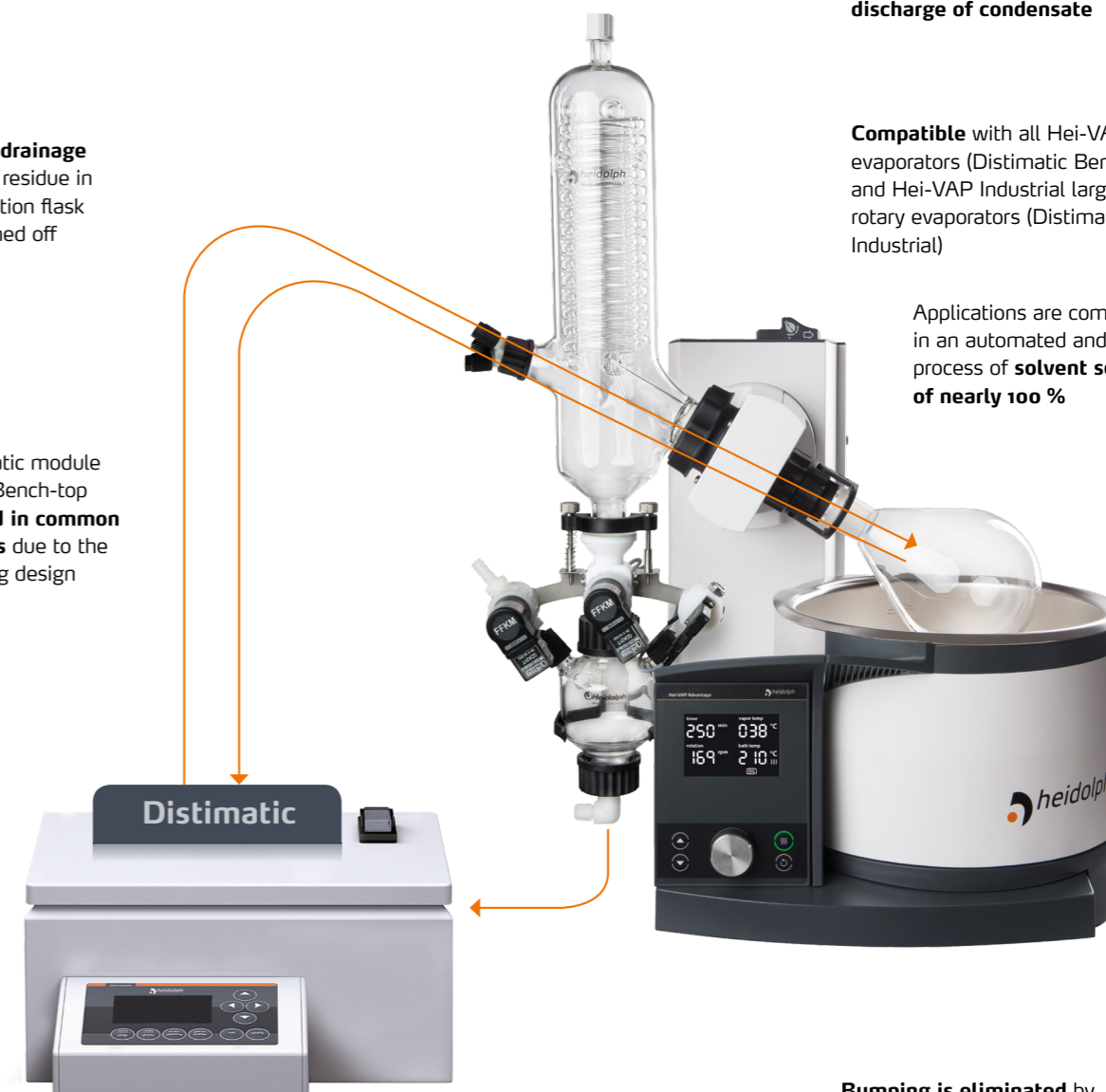

Wide range of possibilities to **adjust settings according to your individual needs**

In case of an emergency **the complete system will power off entirely**

**Bumping is eliminated** by continuously feeding small volumes

## ➤ Functional Principle

### For unattended and continuous use – including automatic drainage of residue

Save time by distilling large volumes in a continuous and unattended manner overnight and during the weekend

#### Automatic solvent supply of the evaporating flask

- Refilling with the Sensor-Mode runs automatically and is based on the desired level in the evaporation flask
- Refilling with the Time-Mode is done according to individual time parameters

#### Automatic discharge of condensate

- A valve matrix controls the continuous discharge of the condensate from the system into a temporary storage flask. Afterwards the collected condensate will be discharged into the collecting tank by a diaphragm pump

#### End of distillation process

- The process can be terminated automatically after evaporation is completed or manually at any time by the operator

#### Automatic drainage of residue

- The residue in the evaporating flask will be drained into a collecting tank. Afterwards the process starts again automatically by refilling the evaporating flask

## ➤ Distimatic Bench-top / Distimatic Industrial

The automatic module Hei-VAP Distimatic is compatible with all bench-top and large-scale evaporators from Heidolph



**Distimatic Bench-top including automatic drainage of residue**  
P/N 591-53000-00 (G9B)  
P/N 591-53000-02 (G9B XL)

**Distimatic Bench-top without automatic drainage of residue**  
P/N 591-51000-00 (G9B)  
P/N 591-51000-02 (G9B XL)



**Distimatic Industrial including automatic drainage of residue and adaptor piece for glassware set A / A2**  
P/N 591-54000-00

**Distimatic Industrial including automatic drainage of residue and adaptor piece for glassware set R**  
P/N 591-55000-00

**Distimatic Industrial without automatic drainage of residue**  
P/N 591-52000-00

## ➤ Functional Principle

Distimatic Bench-top including automatic drainage of residue

- Vacuum valve
- Collector valve
- Ventilation valve
- Condensate pump
- Residue pump

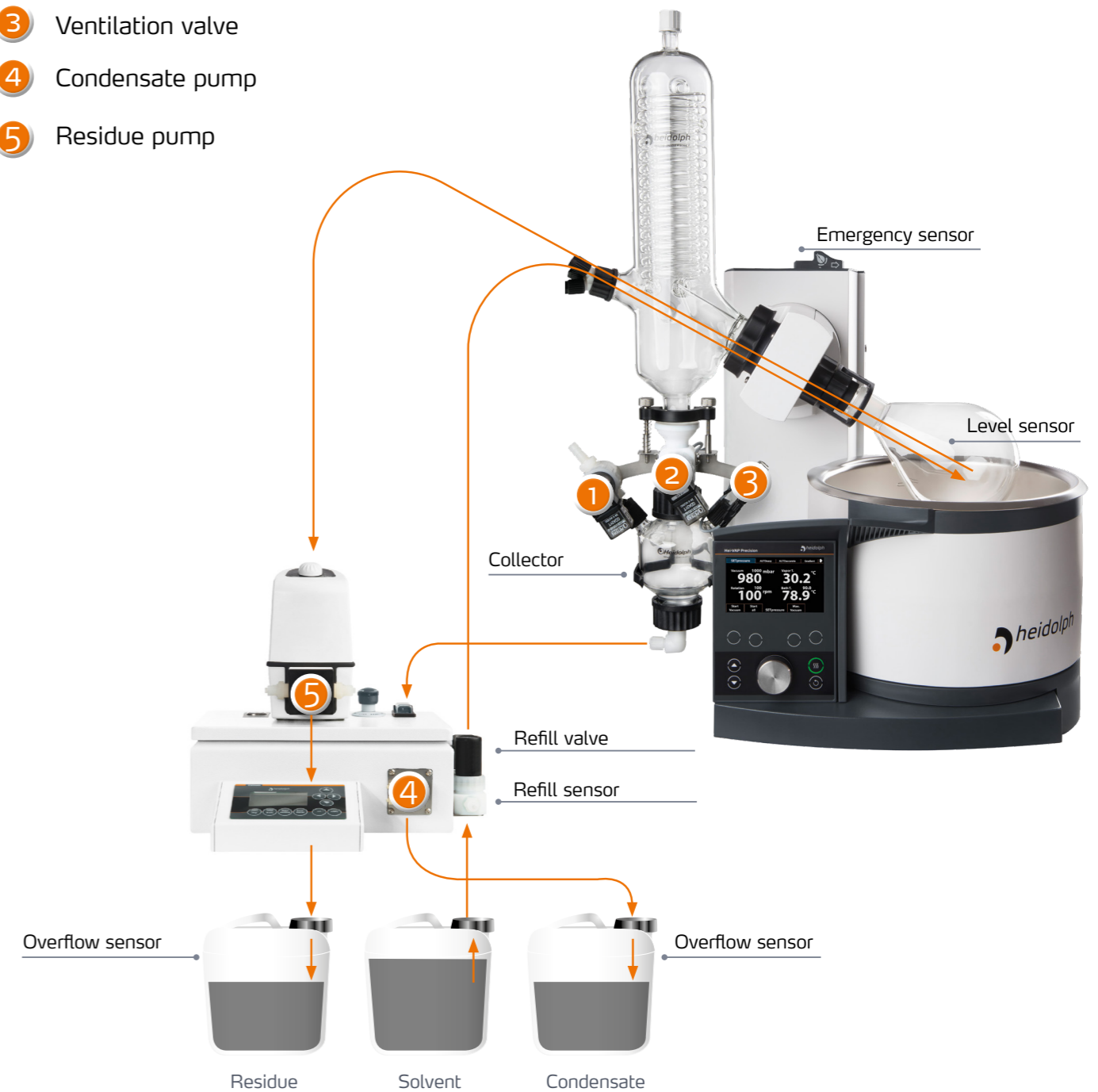

#### Rate of evaporation at continuous operation

- Reach outstanding evaporation rates of up to **6.5 U/h** with the **Distimatic Bench-top** and up to **25.0 U/h** with the **Distimatic Industrial**

## ➤ Distimatic Bench-top Packages

Distimatic Bench-top Platinum Packages	P/N
<b>Distimatic Bench-top Platinum 1 Package</b> Distimatic Bench-top including automatic drainage of residue, Hei-VAP Precision Rotary Evaporator with hand lift and coated, vertical glassware set G9B	563-01914-00
<b>Distimatic Bench-top Platinum 2 Package</b> Distimatic Bench-top including automatic drainage of residue, Hei-VAP Precision Rotary Evaporator with motor lift and coated, vertical glassware set G9B	564-01914-00
<b>Distimatic Bench-top Platinum 2 XL Package</b> Distimatic Bench-top including automatic drainage of residue, Hei-VAP Precision Rotary Evaporator with motor lift and coated, vertical glassware set G9B XL	564-01915-00
<b>Distimatic Bench-top Platinum 3 Package</b> Distimatic Bench-top without automatic drainage of residue, Hei-VAP Precision Rotary Evaporator with hand lift and coated, vertical glassware set G9B	563-01913-00
<b>Distimatic Bench-top Platinum 4 Package</b> Distimatic Bench-top without automatic drainage of residue, Hei-VAP Precision Rotary Evaporator with motor lift and coated, vertical glassware set G9B	564-01913-00
<b>Distimatic Bench-top Platinum 4 XL Package</b> Distimatic Bench-top without automatic drainage of residue, Hei-VAP Precision Rotary Evaporator with motor lift and coated, vertical glassware set G9B XL	564-01917-00

## ➤ Distimatic Industrial Packages

Distimatic Industrial Platinum Packages	P/N
<b>Distimatic Industrial Platinum 1 Package</b> Distimatic Industrial including automatic drainage of residue and Hei-VAP Industrial with glassware set R	518-11155-00
<b>Distimatic Industrial Platinum 2 Package</b> Distimatic Industrial including automatic drainage of residue and Hei-VAP Industrial with glassware set A	518-13154-00
<b>Distimatic Industrial Platinum 3 Package</b> Distimatic Industrial including automatic drainage of residue and Hei-VAP Industrial with glassware set A2	518-14154-00
<b>Distimatic Industrial Platinum 4 Package</b> Distimatic Industrial without automatic drainage of residue and Hei-VAP Industrial with glassware set A2	518-14152-00
<b>Distimatic Industrial Platinum 5 Package</b> Distimatic Industrial without automatic drainage of residue and Hei-VAP Industrial with glassware set A	518-13152-00
<b>Distimatic Industrial Platinum 6 Package</b> Distimatic Industrial without automatic drainage of residue and Hei-VAP Industrial with glassware set R	518-11152-00
<b>Distimatic Industrial Platinum 7 Package</b> Distimatic Industrial including automatic drainage of residue and Hei-VAP Industrial with glassware set A1	518-14154-20
<b>Distimatic Industrial Platinum 8 Package</b> Distimatic Industrial without automatic drainage of residue and Hei-VAP Industrial with glassware set A1	518-14152-20

## ➤ Functional principle Distimatic



[www.heidolph.com](http://www.heidolph.com)



## Technical Specifications - Automatic Module Distimatic

Model	Distimatic Bench-top without drainage of residue	Distimatic Bench-top including drainage of residue
P/N (230 V)	591-51000-00	591-53000-00
Compatibility (Rotary Evaporators)	Hei-VAP and Laborota 4000 series	Hei-VAP and Laborota 4000 series
Separate control panel	yes	yes
Display	digital	digital
Automatic refill of sample	yes	yes
Automatic discharge of condensate	yes	yes
Automatic drainage of residue	no	yes
Power input control box (VA)	50	50
Noise level (dB(A))	< 80	< 80
Total power multiple switched socket (W)	3,500	3,500
Weight (kg)	5	5
Measurements without mounted components (W x D x H) (mm)	300 x 200 x 120	300 x 200 x 120
Permissible ambient conditions	5 – 31 °C at 80 % rel. humidity 32 – 40 °C decreasing linearly up to max. 50 % rel. humidity 0 - 2000 m a.s.l., Contamination level 2 Overvoltage category II	5 – 31 °C at 80 % rel. humidity 32 – 40 °C decreasing linearly up to max. 50 % rel. humidity 0 - 2000 m a.s.l., Contamination level 2 Overvoltage category II
Protection class (DIN EN 60529)	IP 54	IP 54

Model	Distimatic Industrial without drainage of residue	Distimatic Industrial including drainage of residue
P/N (230 V)	591-52000-00	591-54000-00 Glassware A / A2 591-55000-00 Glassware R
Compatibility (Rotary Evaporators)	Hei-VAP Industrial and Laborota 20 series	Hei-VAP Industrial and Laborota 20 series
Separate control panel	yes	yes
Display	digital	digital
Automatic refill of sample	yes	yes
Automatic discharge of condensate	yes	yes
Automatic drainage of residue	no	yes
Power input control box (VA)	50	50
Noise level (dB(A))	< 80	< 80
Total power multiple socket (W)	3,500	3,500
Weight (kg)	5	5
Measurements without mounted components (W x D x H) (mm)	300 x 200 x 120	300 x 200 x 120
Permissible ambient conditions	5 – 31 °C at 80 % rel. humidity 32 – 40 °C decreasing linearly up to max. 50 % rel. humidity 0 - 2000 m a.s.l., Contamination level 2 Overvoltage category II	5 – 31 °C at 80 % rel. humidity 32 – 40 °C decreasing linearly up to max. 50 % rel. humidity 0 - 2000 m a.s.l., Contamination level 2 Overvoltage category II
Protection class (DIN EN 60529)	IP 54	IP 54

All shown values relate on Automatic Module Distimatic without any external accessory parts  
To check the compatibility please contact your dedicated Heidolph contact person

# Certificate

To confirm the ability for  
continuous operation  
of the Automatic Module Distimatic

The Automatic Module Distimatic features overtemperature safety circuits according to DIN EN 61010-1: 2011-07 and therefore is designed for continuous operation.

This statement is made under the precondition that all units are operated in accordance with the operation manual and in accordance with good practice standards for safety in laboratories, rules for accident preventions, and compliance with directions on hazardous materials.

Schwabach, January 2018



Stefan Peters  
Research and Development Manager



Marcell Sarré  
Quality Manager

# Safe

## Heating and Mixing



### Hei-PLATE Magnetic Stirrers

Leading Safety Standards

Superior Ease of Use

Reduced Cost of Ownership



 **heidolph**  
research made easy





Have you ever heard of hotplates with fast heat-up times and chemical resistance?

## Safe Heating and Mixing

The unique Kera-Disk® heating plate of aluminum provides fast heating times, and the wafer-thin ceramic coating makes the heating plate both chemically and scratch resistant!

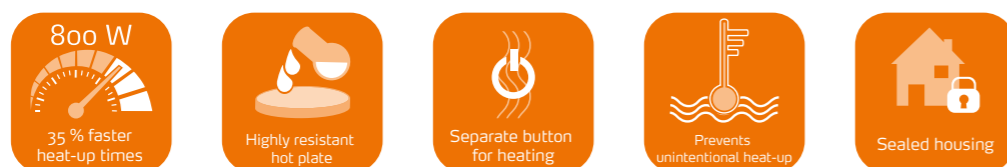

## Leading Safety Standards

- To prevent accidents or laboratory fires, all magnetic stirrers feature **two independent safety circuits** which switch off heating in case of any overtemperature situation
- In combination with Heat-On attachments you can convert your lab into a "safety zone"
- A residual heat indicator for all models **prevents you from potential burning hazards**
- For your safety, the **unit will power off** in case of a short-circuit, a damage to the temperature sensor, a motor failure or other incidences during operation
- To protect you from splashes and scalding from bath media, rotation speed **ramps up slowly** until unit has reached the pre-programmed speed
- A separate on/off switch for heating **prevents unintentional heat-up.** If heating is switched on, the on/off button is illuminated for visual control
- Even if the stirrer is exposed to the highest temperatures, damage is categorically ruled out – all models come with a **fire-resistant aluminum die-cast housing**

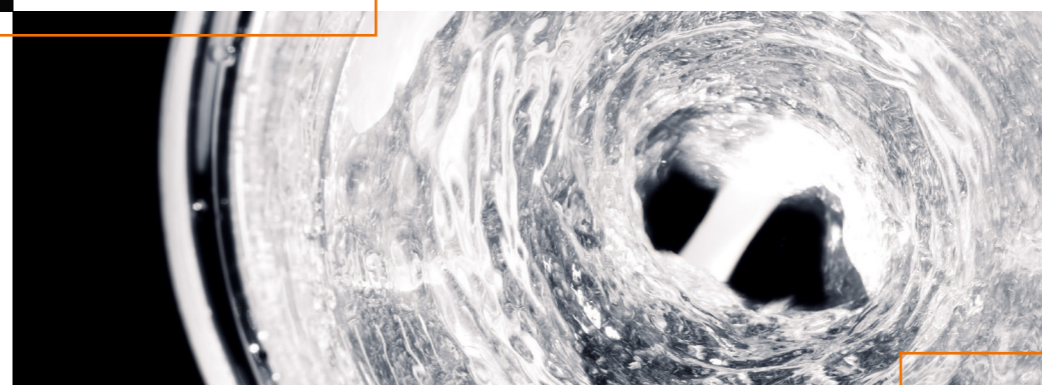



## Reduced Cost of Ownership

- **Reduce your process times!** The extended heating capacity of 800 W reduces your heat-up time by 35 % compared to other units at 600 W
- The **hermetically-sealed housing** protects all mechanical and electronic components from aggressive environments
- The maintenance-free non-sparking motors **reduce down times**
- The design and features give an **increased lifespan of 10 years** along with significantly **reduced maintenance and repair costs**

## Superior Ease of Use

- All units with digital display allow for easy setting and monitoring values on the **illuminated readout**
- You can even **work with dry ice** – a robust thermal insulation prevents corrosion inside the housing by preventing condensate from collecting and dripping on any electronic components
- A free software program is available for the MR Hei-Connect and MR Hei-End which supports you to automate and to **safe your process parameters**
- The strong magnetic field allows for **easy stirring** of even higher **viscosity media**
- The unique Kera-Disk® coating is extremely chemical-resistant and scratch-proof, and therefore the plate can be **cleaned easily** from solvents, oil or other contaminations
- The chemically resistant Kera-Disk® hot plate allows for **immediate heat transfer** resulting in quick heat-up times
- In case the heating function fails, stirring will not be discontinued to **avoid thermal damage** to your sample



# Safe Heating and Mixing

Leading Safety Standards

Superior Ease of Use

Reduced Cost of Ownership

## ➤ Kera-Disk® top plate

With Kera-Disk® material coating, fast heat-up times and chemical resistance!



### YOUR ADVANTAGES

- Glass ceramic top plates offer the benefits of chemical and scratch resistance but produce longer heat-up times
- Aluminum top plates allow for immediate heat transfer but are not chemical-resistant or scratch-proof
- Kera-Disk® top plates take the best of two worlds: The aluminum top plate allows for immediate heat transfer for quick heat-up times and a thin layer of ceramic coating makes the top plate chemical-resistant and scratch-proof

## ➤ Performance and Accuracy

Take advantage of a built-in PID controller that ensures fastest heat-up times while preventing an overtemperature situation of your sample

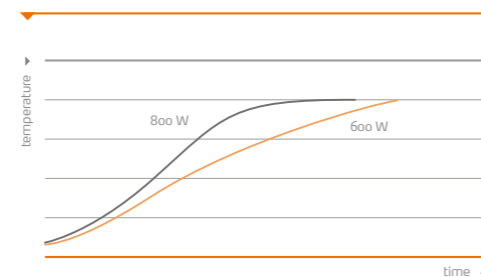

## ➤ Sealed housing

The sealed housing of the MR series guarantees extended performance life and reduced maintenance!

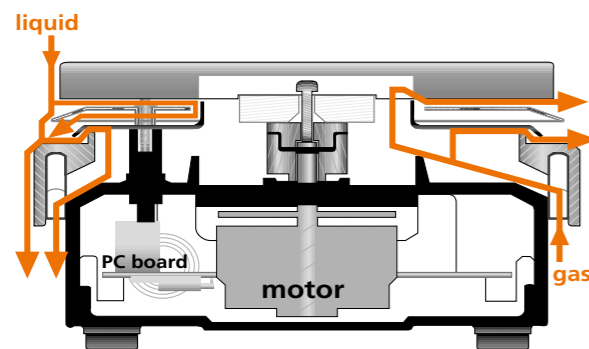

### YOUR ADVANTAGES

- Protection against aggressive fumes, liquids and vapors which prevents internal corrosion. This results in an increased lifespan of 10 years on average at reduced maintenance and repair cost
- Protection of all mechanical and electronic components against aggressive environmental conditions

The hermetically-sealed housing that protects the PC board and the motor is marked in black. The way a liquid would take flowing down from the hotplate is marked in orange. As one can see, even if the liquid reaches the heat shields, it cannot ingress to the PC board and the

motor but is drained off. The other line marked in orange shows that gas can neither ingress to the PC board nor to the motor. The apparent gap is due to temperature insulation. Because of that gap the temperature inside the magnetic stirrer stays substantially lower, which

significantly increases the durability of the magnetic stirrer. For protection against liquid and gas, the heating elements are completely embedded in ceramic.

The average operational **lifespan of 10 years** is backed by a **3 year warranty** and makes your purchase a worthwhile investment.

The standard RS 232 interface of the MR Hei-Connect and MR Hei-End enables the **documentation and controlling via PC**. A free software is available on our website

The extended heating capacity of **800 W** reduces heat-up times by **35 %** compared to other units at 600 W

The chemically resistant Kera-Disk® hot plate allows for **immediate heat transfer** resulting in quick heat-up times

Hermetically-sealed housing **protects** all mechanical and electronic components **from aggressive environments**

In case the heating function fails, stirring will not be discontinued to **prevent bumping**

The temperature sensor consists of **two independent safety circuits** which switches off heating in case of any overtemperature situation

In case of a short-circuit, a damage or removal of the temperature sensor from the media, the **unit powers off completely**

Damage to the stirrer is categorically ruled out even if exposed to highest temperatures – all models come with **a fire-resistant aluminum die-cast housing**

A separate on/off button for heating **prevents unintentional heat-up** – the button is illuminated for visual control. In addition, the residual heat indicator **prevents from potential burning hazards**



## ➤ Magnetic Stirring Hotplates

Preferred use of the MR Series magnetic stirrers includes smooth to intense mixing and heating of low-viscosity fluids. Your first choice for decomposing organic and inorganic substances

- With a heating power of 800 W the hotplate reaches a maximum temperature of 300 °C in a significantly reduced time period
- Safety circuits avoid an overheat situation of your hotplate: if the temperature overshoots the heating will be powered off immediately
- The strong magnetic field allows for stirring even higher viscosity media or volumes of 20 liters of water with ease
- Speed is adjustable from 30 respectively 100 to 1,400 rpm at an accuracy of up to  $\pm 1\%$  for gentle mixing

For standard applications without temperature sensor

For higher requirements

For comprehensive process documentation

For highest safety



MR Hei-Standard



MR Hei-Tec



MR Hei-Connect



MR Hei-End

## ➤ MR Hei-Standard

**Model for standard applications without temperature sensor**

Easy handling and direct access to all parameters due to two separate knobs

- For your protection an independent safety circuit will switch off heating if hotplate temperature exceeds 25 °C over set temperature
- A separate on/off switch for heating prevents an unintentional heat-up. If heating is switched on the on/off button is illuminated for visual control. In addition, a residual heat indicator prevents from burning hazards when heat function is switched off
- Analog knobs allow for convenient speed setting from 100 to 1,400 rpm at an accuracy of  $\pm 2\%$  and temperature setting up to 300 °C



MR Hei-Standard  
P/N 505-20000-00

## ➤ MR Hei-Tec

**Model for higher requirements with temperature sensor**

A digital display enables full process monitoring and precise setting of all parameters

- This unit features a digital display and allows for easy setting and monitoring of values in the illuminated readout
- For your protection an independent safety circuit will switch off heating if hotplate temperature exceeds 25 °C over set temperature
- Digital speed setting from 100 to 1,400 rpm at an accuracy of  $\pm 2\%$  and temperature setting up to 300 °C
- A separate on/off switch for heating prevents an unintentional heat-up. If heating is switched on the on/off button is illuminated for visual control. In addition, a residual heat indicator prevents from burning hazards when heat function is switched off
- An illuminated button indicates clearly if the stirring mode is activated
- Upgrade this magnetic stirrer with the optional Pt 1000 temperature sensor for precise temperature control, overshoot protection and reproducible results
- To protect your sample from overheating, a safety circuit switches off heating if the temperature sensor is not inserted into your media vessel when heating is commenced

MR Hei-Tec  
P/N 505-30000-00

MR Hei-Tec with Pt 1000  
P/N 505-30081-00



## ➤ MR Hei-Connect

**Model for comprehensive process documentation and reproducible results**

The MR Hei-Connect includes all features of the MR Hei-Tec unit but comes with an additional RS 232 interface

- Monitor and control your process with the Hei-Control software or your own program
- Benefit from reproducible results and the option to program ramps and interval processes
- Hei-Control software included in the scope of delivery

MR Hei-Connect  
P/N 505-40000-00

MR Hei-Connect with Pt 1000  
P/N 505-40081-00



## MR Hei-End

### Model for highest safety

Exact settings and individual definition of safety parameters for highly sensitive media

- An independent safety circuit switches off heating at an operator-programmed temperature value above your set temperature
- An additional operational safety step is required to change parameters which prevents unwanted changes to the actual setting
- The digital display allows for easy setting and monitoring of values on the illuminated readout. Speed setting from 30 to 1,400 rpm at an accuracy of  $\pm 1\%$  and temperature setting up to 300 °C
- Hotplate residual heat indicator in the digital display illuminates when unit is turned off and hotplate temperature is above 50 °C to prevent accidental operator injury
- To protect your sample from overheating a safety circuit switches off heating if the temperature sensor is not immersed in your media vessel
- A separate on/off switch for heating prevents an unintentional heat-up. If heating is switched on the on/off button is illuminated for visual control
- Upgrade this magnetic stirrer with the optional Pt 1000 temperature sensor for precise temperature control, overshoot protection and reproducible results



**MR Hei-End**  
P/N 505-50000-00

**MR Hei-End with Pt 1000**  
P/N 505-50081-00

### Software Hei-Control

- Utilize the optional software to control and document the entire process
- MR Hei-End and MR Hei-Connect featuring a digital RS 232 interface for connecting the optional software easily
- Connect up to four units at the same time
- Included in scope of delivery with MR Hei-Connect
- Compatible with MR Hei-End and Hei-TORQUE devices

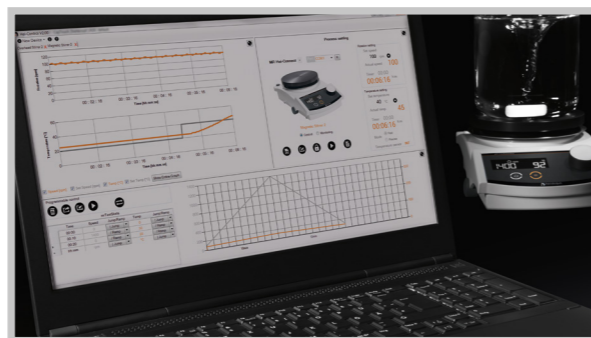

**Free download of Hei-Control Software for MR Hei-Connect and MR Hei-End at**  
[www.heidolph.com/support](http://www.heidolph.com/support)

## Accessories

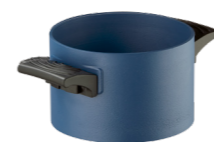

**1-l Heating bath**  
PTFE-coated  
P/N 504-93100-00



**2-l Heating bath**  
PTFE-coated  
P/N 504-92100-00



**4-l Heating bath**  
PTFE-coated  
P/N 504-91100-00



**Concave block adaptor**  
For 1-l round-bottom flasks  
P/N 504-94000-00



**1-l Heating bath for oil**  
Max. temperature 250 °C  
P/N 504-93000-00



**2-l Heating bath for oil**  
Max. temperature 250 °C  
P/N 504-92000-00



**4-l Heating bath for oil**  
Max. temperature 250 °C  
P/N 504-91000-00



**Holding device MR**  
For safe fixation on lab frames to gain extra lab space. Comes with clamp as standard  
P/N 509-96000-00



**Pt 1000 clamping system**  
(includes support rod and attachment with cable inlet)  
P/N 509-63100-00  
**Pt 1000 clamping system for bath attachments from 3 to 5 liter**  
(includes support rod and attachment with cable inlet)  
P/N 509-63200-00



**Pt 1000 temperature sensor stainless steel**  
For MR Hei-Tec, MR Hei-Connect and MR Hei-End  
P/N 509-67910-00



**RS 232 cable (9-pole)**  
For MR Hei-Connect and Hei-TORQUE Precision models  
P/N 14-007-040-72



**RS 232 cable (15-pole)**  
For MR Hei-End  
P/N 14-007-045-17



**Silicone protective cover**  
Replaceable cover against splashes and dripping water

For MR Hei-Tec, MR Hei-Connect and MR Hei-End  
P/N 23-07-06-05-59  
For MR Hei-Standard  
P/N 23-07-06-05-63

### Stirring bars

	P/N
<b>Stirring bars - cylindrical shape</b> (25, 40, 50 mm each)	509-56000-00
<b>Stirring bars - cross shape (16.5 mm)</b> pack of 20 pcs. for 25-ml to 50-ml flasks	509-58500-00
<b>Stirring bars Evaluation Kit</b> pack of 10 pcs.	509-58300-00
<b>Stirring bars - oval shape (15x6 mm)</b> pack of 3 pcs. for 10-ml flasks	509-53000-00
<b>Stirring bars - oval shape (25x10 mm)</b> pack of 3 pcs. for 25-ml to 50-ml flasks	509-54000-00
<b>Stirring bars - oval shape (30x10 mm)</b> pack of 3 pcs. for 100-ml to 250-ml flasks	509-55000-00

## Heat-On Attachments

The Heat-On attachments are suitable to replace oil baths and heating mantles in your lab and reduce the risk of fire hazards. Moreover the attachments minimize the messy oil clean-ups that result from changing oil or removing flasks from an oil bath!



- Our attachments are by far the safest, fastest and most efficient method for heating and mixing solutions in round-bottom flasks from 10 ml to 5 liter
- Heat-On fits precisely to every flask, thus ensuring maximum surface contact and fast heat transfer. Eliminates the mess from cleaning flasks after removal from an oil bath or hazardous spills when an oil bath slips off a stirring plate. As a result, oil as a heat transfer media is made redundant and your lab is a safer place with the Heat-On block system

Flask volume	Volume of water	Hotplate temperature	Time to reach boiling
10 ml	6 ml	300 °C	6.8 min
25 ml	15 ml	300 °C	8.0 min
50 ml	30 ml	300 °C	8.5 min
100 ml	60 ml	300 °C	8.8 min
150 ml	100 ml	300 °C	10.0 min
250 ml	150 ml	300 °C	10.8 min
500 ml	300 ml	300 °C	16.4 min
1,000 ml	600 ml	300 °C	21.1 min
2,000 ml	1,200 ml	300 °C	35.1 min
3,000 ml	1,800 ml	300 °C	47.3 min
4,000 ml	2,400 ml	300 °C	51.0 min
5,000 ml	3,000 ml	300 °C	75.5 min

### Leading Safety Standards

- Prevents accidents, fires and contamination by completely banning all oil baths from your laboratory
- This unique design prevents glass breakage and protects you from spilled chemicals or solvents
- The high temperature range provides unlimited safety for applications up to 260 °C

### Superior Ease of Use

- A unique PTFE-coating on the aluminum Heat-On body allows for superior chemical resistance and many years of service life
- Precise temperature control inside the vessel or on the heating block with a thermocouple port that provides actual block temperature back to your MR series hotplate

### Reduced Cost of Ownership

- Increase your daily work throughput significantly and reduce your overall process times by quick changing of Heat-On blocks
- Save energy costs – 1,000 ml of water heats up 66 % faster than conventional oil baths
- 150 ml of water boils in less than 11 minutes

## Heat-On Attachments

### Heat-On blocks

Each Heat-On block is a stand-alone product that can be placed directly onto the stirring hotplate

- Heat-On 100-ml block** with flask sidearm cutouts 505-80066-00
- Heat-On 250-ml block** 505-80067-00
- Heat-On 250-ml block** with flask sidearm cutouts 505-80067-01
- Heat-On 500-ml block** 505-80069-00
- Heat-On 1-l block** 505-80071-00
- Heat-On 2-l block** 505-80073-00
- Heat-On 3-l block** 505-80075-00
- Heat-On 4-l block** 505-80078-00
- Heat-On 5-l block** 505-80076-00



Heat-On 250-ml block with flask sidearm cutouts



Heat-On 2-l block

### Heat-On accessories

- Support rod for bath attachments from 3 to 5 liter** 509-97000-00
- Retort clamp** 505-81075-00
- Boss head** 570-31100-00
- Flask Stand & Clamp Kit** 505-81400-00  
(including Support rod for bath attachments from 3 to 5 liter, Retort clamp, Boss head)

### PTFE Safety Covers\*

- For Heat-On Multi-Well holder** 505-80080-00
- For Heat-On 200-300-ml block** 505-80081-00
- For Heat-On 500-ml block** 505-80082-00
- For Heat-On 1-l block** 505-80083-00



PTFE safety covers



PTFE safety cover 500 ml

\* Not available in the USA

### Multi-Well holder and inserts

This unique Multi-Well holder is designed to hold either one or two inserts for flasks\*.

The inserts are available for 10-ml, 25-ml, 50-ml, 100-ml and 150-ml flasks. Flask inserts also feature cut-away sides for use with two or three-neck flasks and accept the optional safety lifting handles

\* Only accepts one 150-ml insert

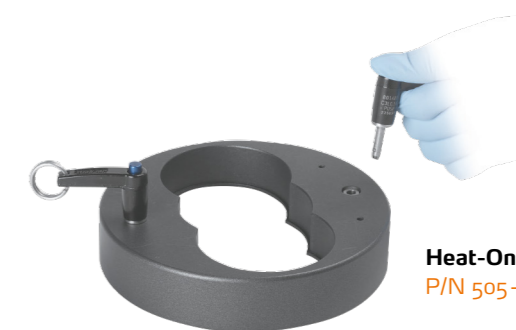

Heat-On Multi-Well holder  
P/N 505-80060-00

Heat-On safety lifting handles  
P/N 505-80077-00

### Insert for Multi-Well holder

- Heat-On 10-ml insert** 505-80061-00
- Heat-On 25-ml insert** 505-80062-00
- Heat-On 50-ml insert** 505-80063-00
- Heat-On 100-ml insert** 505-80064-00
- Heat-On 150-ml insert** 505-80065-00



Heat-On 10-ml insert



Heat-On 50-ml insert

### Heat-On Multi-Well packages

- Package Heat-On Multi-Well Basic** 505-81300-00  
Including 1x Multi-Well holder and 3 inserts for 25-ml, 50-ml and 100-ml flasks

- Package Heat-On Multi-Well** 505-81200-00  
Including 1x Multi-Well holder and 6 inserts, 2 each for 25-ml, 50-ml and 100-ml flasks

## StarFish Workstations

Have you always been looking for a system to perform numerous reactions on a small footprint to significantly reduce space and process times?

With our attachments you can turn your magnetic stirrer into an efficiency-increasing reaction station for up to 45 samples simultaneously!

- Upgrade your magnetic stirrer to a product with multiple capabilities
- From simple heating and mixing tasks to chemical reactions under inert gas, concentrations or extractions - everything is possible
- No special glassware purchase required - use your own glassware and cherry-pick the appropriate attachments for your applications
- StarFish workstations are ideal for soxhlet applications



### Base plate

Base plate with optional handles fits securely onto the top plate maintaining good thermal contact with the heated surface

StarFish base plate (145 mm)  
505-81000-00

StarFish base plate handles (pair)  
505-81001-00



#### Numerous combinations

Cherry-pick from different PolyBlock options in different sizes or one MonoBlock system for identical round-bottom flasks or vials. In addition, you can choose from a large selection of inserts ranging from 5 ml to 150 ml

### MonoBlocks

MonoBlocks are single blocks with multiple wells all of the same size and are ideal for experiments using the same vessel

MonoBlock for 5 x 250-ml flasks 505-80001-00

#### Inserts for MonoBlock 5 x 250 ml

150-ml Flask insert 505-80040-00  
100-ml Flask insert 505-80041-00  
50-ml Flask insert 505-80042-00  
25-ml Flask insert 505-80043-00  
10-ml Flask insert 505-80044-00  
5-ml Flask insert 505-80045-00

MonoBlock for 16 x 25-mm tubes 505-80002-00  
MonoBlock for 16 x 24-mm tubes 505-80003-00  
MonoBlock for 40 x 16-mm tubes 505-80004-00  
MonoBlock for 40 x 12-mm tubes 505-80005-00

MonoBlock for 16 x 28-mm vials 505-80006-00  
MonoBlock for 20 x 21-mm vials 505-80007-00  
MonoBlock for 40 x 17-mm vials 505-80008-00  
MonoBlock for 40 x 15-mm vials 505-80009-00  
MonoBlock for 40 x 12-mm vials 505-80010-00

### PolyBlocks

PolyBlocks are smaller segments (five per StarFish) which can be mixed to accommodate any combination of vessels; allowing the use of different vessel types and sizes at the same time

PolyBlock for 1 x 250-ml flask 505-80020-00

PolyBlock for 3 x 25-mm tubes 505-80021-00  
PolyBlock for 3 x 24-mm tubes 505-80022-00  
PolyBlock for 9 x 16-mm tubes 505-80023-00  
PolyBlock for 9 x 12-mm tubes 505-80024-00

PolyBlock for 3 x 28-mm vials 505-80025-00  
PolyBlock for 3 x 21-mm vials 505-80026-00  
PolyBlock for 7 x 17-mm vials 505-80027-00  
PolyBlock for 9 x 15-mm vials 505-80028-00  
PolyBlock for 9 x 12-mm vials 505-80029-00

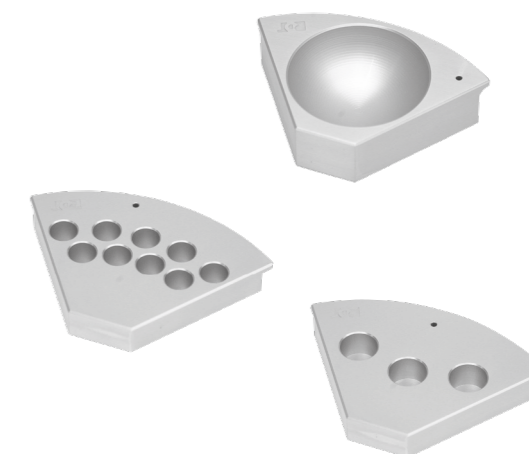

5-way clamp (Velcro)  
P/N 505-81010-00



5-way clamp (Silicone strap and handle)  
P/N 505-81020-00

### Universal 5-way clamps

The StarFish clamp allows you to hold glassware of virtually any size and comes with a choice of Silicone rubber or Velcro support straps

Each clamp features five telescopic arms which can be extended and locked in place to suit your needs. Using different straps on separate clamps allows you to grip the flask neck with the Silicone rubber strap for lifting, whilst the condenser above slides through the Velcro strap

### Water-Distribution Manifold

Allows coolant from a single source to be evenly distributed to up to five condensers and then recombines the flow to one outlet pipe

Two manifolds are used in each set-up, one to distribute water to the condenser and one to collect coolant for recirculation or to drain. Connectors feature leak-proof shut-off valves



Water Manifold  
With connector  
P/N 505-81030-00



Gas/Vacuum Manifold  
With connector  
P/N 505-81040-00

### Gas/Vacuum-Distribution Manifold

Allows gas or vacuum from a single source to be evenly distributed to up to five positions or vessels (does not control or regulate gas/vacuum flow). Connectors feature leak-proof shut-off valves

Replacement Self Adhesive Velcro Pads, 200 mm (pack of 10) 505-81070-00  
Replacement Velcro Loop Strips, 200 mm (pack of 5) 505-81080-00  
Replacement Silicone Straps, 200 mm (pack of 5) 505-81090-00  
650 mm Support rod 505-81050-00  
650 mm Support split rod 505-81060-00

## ➤ Magnetic Stirrer without Heating

For gentle stirring in biology and microbiology applications

### Hei-Mix S

- Stir quickly and efficiently with an extended speed range up to 2,200 rpm
- Space-saving unit for efficiently mixing sample sizes up to 5 liter. Small footprint of L 140 / W 126 / H 80 mm only and the top plate comes with a diameter of 104 mm
- Ideal for titrations due to white-colored top plate
- Long-lasting polyamide housing and PVDF top plate material

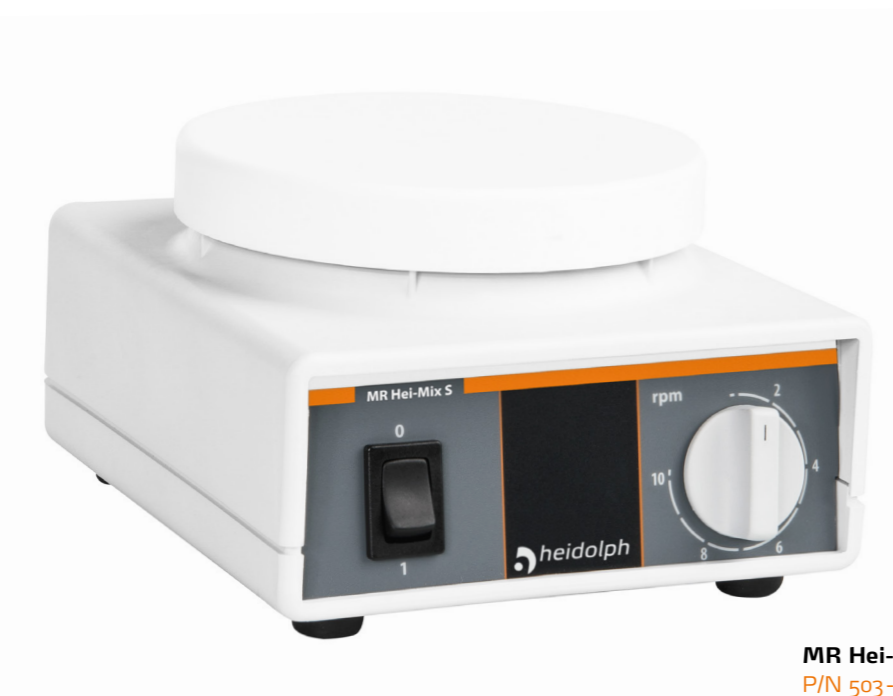

**MR Hei-Mix S**  
P/N 503-02000-00

## ➤ Magnetic Stirrer Packages



### MR Silver 1 Package

P/N 505-30080-00

**This package includes:**

- Magnetic Stirrer MR Hei-Tec
- Temperature sensor Pt 1000 (AISI 316Ti)
- Pt 1000 clamping system (includes support rod and attachment with cable inlet)

### MR Silver 2 Package

P/N 505-40080-00

**This package includes:**

- Magnetic Stirrer MR Hei-Connect
- Temperature sensor Pt 1000 (AISI 316Ti)
- Pt 1000 clamping system (includes support rod and attachment with cable inlet)
- Interface cable RS 232



### MR Gold 1 Package

P/N 505-81600-00

**This package includes:**

- Magnetic Stirrer MR Hei-Tec
- Temperature sensor Pt 1000 (AISI 316Ti)
- Pt 1000 clamping system (includes support rod and attachment with cable inlet)
- Heat-On Multi-Well system including Multi-Well holder and the following inserts: 2 x 25 ml, 2 x 50 ml, 2 x 100 ml

### MR Gold 2 Package

P/N 505-81500-00

**This package includes:**

- Magnetic Stirrer MR Hei-Standard
- Heat-On Multi-Well system including Multi-Well holder and the following inserts: 2 x 25 ml, 2 x 50 ml, 2 x 100 ml



### MR Platinum Package

P/N 505-81100-00

**This package includes:**

- Magnetic Stirrer MR Hei-End
- Temperature sensor Pt 1000 (AISI 316Ti)
- Base plate
- MonoBlock for 5 x 250-ml flasks
- 2 x 100-ml flask insert
- 2 x 50-ml flask insert
- 1 x 25-ml flask insert
- 5-way clamp (velcro strap)
- 5-way clamp (silicone strap & handle)
- 2 x Water Manifold
- 1 x Gas/Vacuum Manifold
- 650-mm split rod



## Technical Specifications - Magnetic Stirrers

Model	MR Hei-Mix S	MR Hei-Standard	MR Hei-Tec	MR Hei-Connect	MR Hei-End
P/N (230 V)	503-02000-00	505-20000-00	505-30000-00	505-40000-00	505-50000-00
Speed range (rpm)	0 - 2,200	100 - 1,400	100 - 1,400	100 - 1,400	30 - 1,400
Speed accuracy (%)	±5	±2	±2	±2	±1
Drive	Shaded pole motor	EC-motor	EC-motor	EC-motor	EC-motor
Operating mode	continuous	continuous	continuous	continuous	continuous
Display	-	-	digital	digital	digital
Analog/digital interface	-	-	-	yes (digital)	yes
Heating power (W)	-	800 *	800 *	800 *	800 *
Hotplate temperature (°C)	-	20 - 300	20 - 300	20 - 300	20 - 300
Medium temperature, max. (°C)	-	250	250	250	250
Accuracy temperature setting (°C)	-	±5	±1	±1	±1
External temperature sensor	-	Pt 1000	Pt 1000	Pt 1000	Pt 1000
Temperature accuracy with external temperature sensor (°C)	-	±1	±1	±1	±0.2
Sensor breakage protection	-	with Pt 1000	with Pt 1000	with Pt 1000	with Pt 1000
Temperature control	-	Micro controller	Micro controller	Micro controller	Micro controller
Temperature accuracy hotplate (°C)	-	±5	±5	±5	±5
Residual heat indicator	-	yes	yes	yes	yes
Safety circuit hotplate (°C)	-	25 °C over hotplate temperature	25 °C over hotplate temperature	25 °C over hotplate temperature	10 - 25 °C over nominal temperature
Stirring capacity, max. (H <sub>2</sub> O) (l)	5	20	20	20	20
Load, max. (kg)	6	25	25	25	25
Power consumption (W)	7	820	820	820	825
Permissible ambient conditions	5 - 31 °C at 80 % rel. humidity 32 - 40 °C decreasing linearly up to max. 50 % rel. humidity	5 - 31 °C at 80 % rel. humidity 32 - 40 °C decreasing linearly up to max. 50 % rel. humidity	5 - 31 °C at 80 % rel. humidity 32 - 40 °C decreasing linearly up to max. 50 % rel. humidity	5 - 31 °C at 80 % rel. humidity 32 - 40 °C decreasing linearly up to max. 50 % rel. humidity	5 - 31 °C at 80 % rel. humidity 32 - 40 °C decreasing linearly up to max. 50 % rel. humidity
Plate diameter (mm)	Ø 104	Ø 145	Ø 145	Ø 145	Ø 145
Plate material	PVDF	Kera-Disk® (Silumin with ceramic coating)	Kera-Disk® (Silumin with ceramic coating)	Kera-Disk® (Silumin with ceramic coating)	Kera-Disk® (Silumin with ceramic coating)
Weight (kg)	1.1	2.9	2.9	2.9	2.6
Dimensions (L x W x H) (mm)	140 x 126 x 80	173 x 277 x 94	173 x 277 x 94	173 x 277 x 94	173 x 277 x 94
Protection class (DIN EN 60529)	IP 21	IP 32	IP 32	IP 32	IP 32

\* 600 W for 115 V-units  
Standard supply voltage: 230 V - other voltages upon request, please specify for order

# Certificate

To confirm the ability for  
continuous operation  
of the MR series Magnetic Stirrers with hotplate

The MR series Magnetic Stirrers with hotplate feature overtemperature safety circuits according to DIN EN 61010-1:2001 and DIN EN 61010-2-010:2014 and therefore is designed for continuous operation.

This statement is made under the precondition that all units are operated in accordance with the operation manual and in accordance with good practice standards for safety in laboratories, rules for accident preventions, and compliance with directions on hazardous materials.

Schwabach, January 2018



Stefan Peters  
Research and Development Manager



Marcell Sarré  
Quality Manager

# Powerful Stirring



## Hei-TORQUE Overhead Stirrers

Leading Safety Standards

Superior Ease of Use

Reduced Cost of Ownership





Looking for an all-purpose stirrer with smart technology and highest performance to reduce your workload?

## Powerful Stirring

The powerful Hei-TORQUE stirrers accomplish the most demanding tasks while providing the highest safety in combination with a unique user interface

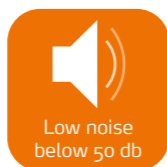

## Leading Safety Standards

- The electronic stirrers feature individual setting of the start operation, which **prevents spills and splashing media**. The speed ramps up slowly until your set rpm has been reached
- An optional shaft guard **prevents accidents**
- **Non-sparking motors** for additional safety
- Important for continuous operation: the motor will be switched off if a high thermal load situation occurs to increase safety in your lab and to **prevent accidents**
- **Safe start and stop** of operation via slide touch panel to avoid accidental start-up
- To protect your stirrer against corrosion and short-circuits, all models comply with the **protection class IP 54**
- Setting a rotation speed limitation **prevents splashing media**



- **Unique Quick-Chuck** for immediate and convenient "one-hand" impeller changing - **without tools**
- Opening the safety ring **blocks accidental operation**
- An audible signal **confirms a tight fit** of the impeller



## Superior **Ease of Use**

- **No more misplacing and searching** for the chuck key! Immediate and convenient "one-hand" impeller changing with the Quick-Chuck - **without any tools**
- **RS 232 and USB interfaces** allow precise documentation of process cycles
- **Free Hei-Control software** for all Hei-TORQUE Precision models aids you with **automating your process, and saves all data** in electronic files
- Newest motor generation for maximum power at **minimum noise level below 50 dB**
- All stirrers maintain **exact speed under changing loads**
- A through-shaft design allows for adjusting the impeller position to make **height adjustments more convenient** for you
- **Reduce your work time** and achieve excellent mixing results in challenging high-viscosity media
- **A single grip** allows you to re-adjust the height of your stirrer on the optional telescopic stand
- The outstanding product design with **intuitive touch-panel** made of glass has been honored with the prestigious **iF DESIGN AWARD in 2016**



## **Reduced Cost** of Ownership

- Reduce your maintenance costs: the sealed housing protects your stirrer from aggressive fumes, liquids and vapors to prevent internal corrosion. This results in an **increased lifespan of 10 years** on average while **reducing maintenance and repair cost**
- The high torque level accounts for better mixing results in less time to **reduce your process time** and working hours significantly
- Maintenance-free motors **reduce repairs and down times** significantly to ensure years of continuous operation
- The unique impeller technology for demanding applications that mixes gels and other similar media in shorter times which **reduces process cost and working hours**
- The sealed panel made of glass **increases the tightness** of the entire housing
- **Free software** for all Hei-TORQUE Precision models avoids the need for additional investments

# Powerful Stirring

Leading Safety Standards

Superior Ease of Use

Reduced Cost of Ownership

## Powerful stirring



### YOUR ADVANTAGES

- An overtemperature sensor preventively shuts off the unit in dangerous heat-up situations – particularly valuable for you in case of unattended continuous operation
- All units are designed for continuous 24-hour operation – including challenging high viscosity applications in polymer research
- The durable design of the Hei-TORQUE series promotes longevity in an aggressive environment: The sealed housing protects against corrosion, ensures years of maintenance-free operation and complies with the high protection class IP 54

## Impellers



### YOUR ADVANTAGES

- Stirrer guides for applications under vacuum or pressure, flex couplings and flex shafts increase your available options
- Through thick and thin: large selection of impellers for every flow and viscosity
- Choose from high-quality stainless steel, plastics or PTFE-coated impellers – we have the right one for your specific needs
- Reduce your process times by utilizing unique technology which creates turbulent flows and a new dynamic motion that stirs gels with ease

The average operational **lifespan of 10 years** is backed by a **3 year warranty** and makes your purchase a worthwhile investment.

Newest motor generation for maximum power at **minimum noise level - below 50 dB**

**Rotation direction change** at Hei-TORQUE Precision 100/200 models

The **intuitive touch-panel** made of glass for easy operation

Sealed housing, which complies with the high protection class IP 54, guarantees longevity and maintenance-free **24-hour operation** in an aggressive environment

**Unique Quick-Chuck** for immediate and convenient "one-hand" impeller changing - **without tools**

**Free Hei-Control software** for all Hei-TORQUE Precision models to **automate and to save** all process parameters



An overtemperature sensor **prevents heat-up situations** particularly valuable in unattended continuous operation

Increased safety with individual performance control: Set the **intensity of the starting operation**, the maximum **rotational speed**, and the maximum **torque limit** according to your application

The sealed panel made of glass **increases the tightness** of the entire housing

**Safe start and stop of operation** via slide touch panel to avoid unintended stirring

USB and standard RS 232 interface for documentation and reproducibility

Reduce process times by utilizing unique VISCO JET® impellers for **mixing gels** and other challenging media **with ease**

## ➤ Hei-TORQUE Value

These stirrers are ideal for standard stirring tasks. They are designed to mix and disperse media that require non-reproducible results in high-viscosity applications



Hei-TORQUE Value 400  
P/N 501-64010-00

Indication of torque tendencies to monitor viscosity changes

Digital 2.4" display for ease of operation

Constant speed even under changing loads

Safe start and stop of operation via slide touch panel to avoid unintended stirring

Newest motor generation for maximum power at minimum noise level

## ➤ Hei-TORQUE Precision

These stirrers are ideal for demanding tasks which have to be reproducible and documentable. The huge number of additional features and operation modes allow for perfect adjustment to your individual application



Accurate torque indication shows any viscosity changes

Rotation direction change at Hei-TORQUE Precision 100/200 models

Constant speed even under changing loads

Digital 3.2" display for ease of operation:

- Allows for preprogrammed profiles
- Saves these profiles in memory
- Interval operation
- Watch rpm and torque graph life
- Timer / Countdown / Real time settings

All **performance-related parameters** can be set **individually**:

- **Intensity of the start** operation - from slow to fast
- The **rotational speed can be limited** to avoid **splashing media**
- The torque limit **prevents damage to the impeller**, e.g. when using fragile impellers in high viscous media

Safe start and stop of operation via slide touch panel to avoid unintended stirring

Newest motor generation provides maximum power at minimum noise level

RS 232 and USB interface to save all process data in a digital file

USB cable included in scope of delivery, RS 232 available as accessory



RS 232 cable (9-pole)  
for Hei-TORQUE Precision models  
P/N 14-007-040-72

Including **free Hei-Control software** for **dependable automation** of all processes. Control up to four devices simultaneously. Also compatible with magnetic stirrers MR Hei-Connect and MR Hei-End of the Hei-PLATE series

Hei-TORQUE Precision 400  
P/N 501-64020-00

## Overview

The differentiation between performance and features enables you to easily configure the right stirrer for your specific application

### Hei-TORQUE Value

#### Basic models

The reliable solution for all standard applications that do not need documentation



### Hei-TORQUE Precision

#### High-end models

The professional stirrer for demanding tasks: several options for individual settings as ramps and interval operation.



USB and RS 232 interfaces allow for documentation and reproducibility, e.g. with the free Hei-Control software (for up to four devices)

	100 Ncm	200 Ncm	400 Ncm
<b>High-end models</b>	Hei-TORQUE Precision 100 P/N 501-61020-00	Hei-TORQUE Precision 200 P/N 501-62020-00	Hei-TORQUE Precision 400 P/N 501-64020-00
<b>Basic models</b>	Hei-TORQUE Value 100 P/N 501-61010-00	Hei-TORQUE Value 200 P/N 501-62010-00	Hei-TORQUE Value 400 P/N 501-64010-00

## RZR 1



RZR 1  
P/N 501-11000-00

### For simple mixing tasks

For media up to 40,000 mPa s and volumes up to 20 liters

The RZR 1 is suitable for torque up to 100 Ncm at a power of 18 W

Slim design fits nicely into your research environment

A manual scale for speed adjustments from 35 - 2,200 rpm

A two-gear stage design allows for high torque at various speeds and provides excellent mixing in short times

## Range of Performance

### 100 Ncm

Performance graph of:

Hei-TORQUE Value 100  
Hei-TORQUE Precision 100

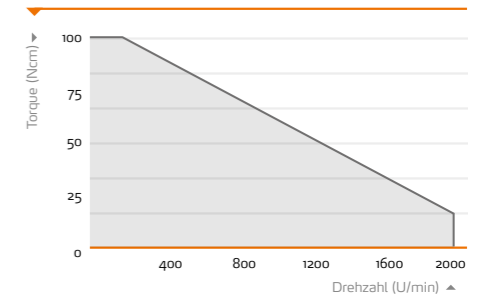

### 200 Ncm

Performance graph of:

Hei-TORQUE Value 200  
Hei-TORQUE Precision 200

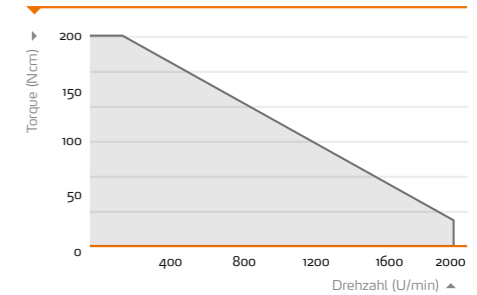

### 400 Ncm

Performance graph of:

Hei-TORQUE Value 400  
Hei-TORQUE Precision 400

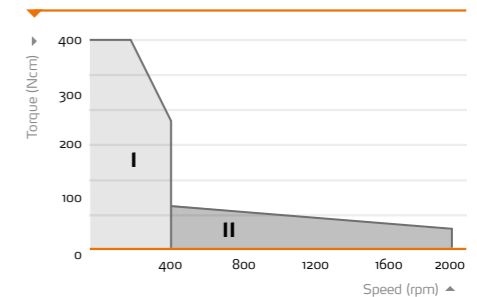

A two-gear stage design enables different torque ranges for flexible applications with high and low viscous media

## Noise Level

Newest motor generation and the complete removal of ventilation slots significantly increase the life-span and ensure stable stirring at clearly reduced noise compared to conventional overhead stirrers



Hei-TORQUE stirrers  
below 50 dB



Other brands  
above 60 dB

## Impellers

### Selection parameters

Precise working with an overhead stirrer depends on the right choice of the stirrer tool. When choosing a stirrer tool you have to consider its different characteristics and their effects. For example, the flow which the tool causes in the medium, the tool's adequate field of application depending on the speed range, and the execution of the tool according to the viscosity it is destined for

#### Application examples:

- Gasging of liquids < 500 mPa s: Radial Flow Impeller
- Homogenizing and suspending in liquids < 500 mPa s: Propeller-Type or Blade Impeller
- Medium with a viscosity > 500 mPa s: Anchor-Type Impeller, Blade Impeller BR 13, VISCO JET®
- Stirring of gel: VISCO JET®

Please ensure that for radial flow, blade, half-moon and VISCO JET® impellers the beaker size and position of your impeller complies with the shown guideline to achieve superior mixing results

### Operational guidelines

#### Position of the stirring tool

- In center
- Distance to the bottom ( $h_3/d_2$ ): 0.3
- Diameter vessel ( $h_1/d_1$ ): 1
- VISCO JET® diameter ratio ( $d_2/d_1$ ): 0.4 - 0.6





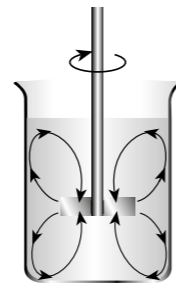
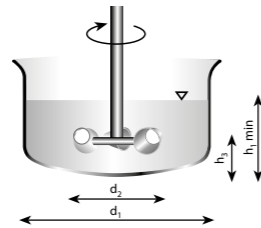

#### Circumferential speed

- 3 - 15 m/sec: Radial Flow Impeller
- 2 - 5 m/sec: VISCO JET®, Blade and Anchor-Type Impeller

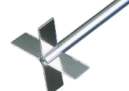

### Blade and Half-Moon Impeller



- These impellers are recommended for applications which require average speed
- For mixing tasks with little or average viscosity
- Models BR 12, BR 14 and HR 18 come with collapsible blade for narrow neck vessels

Type	Blade size [mm]	Material	Length [mm]	Shaft dia. [mm]	Max. rpm	P/N
 BR 10 Cross-Blade Impeller	50 x 12	stainless steel AISI 316Ti	400	8	2,000	509-10000-00
 BR 11 Straight-Blade Impeller	50 x 12	stainless steel AISI 316Ti	400	8	2,000	509-11000-00
 BR 12 Pivoting-Blade Impeller	60 x 15	stainless steel AISI 316Ti	400	8	2,000	509-12000-00
 BR 13 Square-Blade Impeller	70 x 70	stainless steel AISI 316Ti	450	8	800	509-13000-00
 BR 14 Collapsible-Blade Impeller	90 x 10	stainless steel AISI 316Ti	400	8	800	509-14000-00
 HR 18 Half-Moon Impeller	65 x 18 x 3	PTFE	350	8	800	509-18000-00

### Propeller-Type Impeller

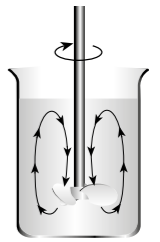
- These impellers are recommended for applications which require average or high speed
- For mixing tasks with medium or high viscosity
- Excellent mixing properties for homogenization and suspensions
- These models create an axial flow



Type	Prop. dia. [mm]	Material	Length [mm]	Shaft dia. [mm]	Max. rpm	P/N
 PR 39 Pitched-Blade Impeller	75	PTFE	350	8	800	509-39000-00
 PR 30 Pitched-Blade Impeller	58	stainless steel AISI 316Ti	400	8	2,000	509-30000-00
 PR 31 Ringed Propeller	33	stainless steel AISI 316Ti	400	8	2,000	509-31000-00
PR 32 Ringed Propeller	45		400	8	2,000	509-32000-00
PR 33 Ringed Propeller	66		400	8	800	509-33000-00

### Radial-Flow Impeller

- These impellers are recommended for applications which require average speed
- For mixing tasks with little or average viscosity up to < 500 mPa s
- Ideal for gasging of liquids
- These impellers create a radial flow

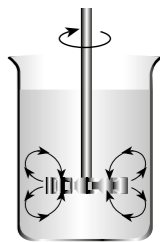

Type	Ø Turbine size [mm]	Material	Length [mm]	Shaft dia. [mm]	Max. rpm	P/N
 TR 20 Radial-Flow Impeller	28	stainless steel AISI 316Ti	400	8	2,000	509-20000-00
TR 21 Radial-Flow Impeller	50	stainless steel AISI 316Ti	400	8	2,000	509-21000-00

### Anchor-Type Impeller

- These impellers are recommended for applications which require a low speed
- For mixing tasks with medium or high viscosity

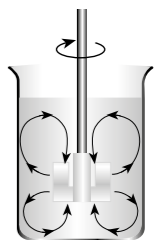

Type	Blade size [mm]	Material	Length [mm]	Shaft dia. [mm]	Max. rpm	P/N
 AR 19 Anchor-Type Impeller	60 x 40 x 5	PTFE	350	8	800	509-19000-00



## ➤ VISCO JET® Impellers

### The all-rounder for thick and thin

- **Reduce your process times** significantly while performing the best mixing results ever
- **One system for literally all mixing tasks** for low to high-viscosity media
- **The turbulent flow** which is created by a special cone principle even at low speeds is **unique to the VISCO JET®**
- Even with high-viscosity media and gels which naturally do not mix when common impellers are used you will observe an immediate flow through the entire beaker
- This technology allows for **de-gassing of gels** while preventing air intake and foaming



Type	Ø [mm]	Material	Length [mm]	Shaft dia. [mm]	Speed range [rpm]	For vessel dia. [mm]	P/N
VISCO JET® - 60*	60	stainless steel AISI 316Ti	500	10	200 - 800	80 - 150	509-16060-00
VISCO JET® - 80*	80	stainless steel AISI 316Ti	500	10	200 - 700	115 - 200	509-16080-00
VISCO JET® - 80*	80	impeller: plastic (POM) hub: brass shaft: polyamide-coated	500	10	200 - 700	115 - 200	509-16081-00
VISCO JET® - 120*	120	stainless steel AISI 316Ti	500	10	120 - 500	170 - 300	509-16120-00
VISCO JET® - 120*	120	impeller: plastic (POM) hub: brass shaft: polyamide-coated	500	10	120 - 500	170 - 300	509-16121-00
VISCO JET® CRACK - 80*	80	stainless steel AISI 316Ti	500	10	200 - 700	115 - 200	509-17080-00
VISCO JET® CRACK - 120*	120	stainless steel AISI 316Ti	500	10	120 - 500	170 - 300	509-17120-00

\* A shaft is included as a standard

**VISCO JET® - CRACK - 120 mm**  
stainless steel



**VISCO JET® - 60 mm**  
stainless steel



**VISCO JET® - 80 mm**  
plastic (POM)



**VISCO JET® - 120 mm**  
stainless steel



### Application examples

The **only impeller world wide** capable of completely mixing larger quantities of high-viscosity liquids and gels

#### Fields of use:

Beverage production, dairy products, food, sugar & candy production, chemistry/petro chemistry, ceramics, water treatment, cosmetics, colorant/paint production and paper manufacture, etc.

### Principle of functionality

The VISCO JET® Mixing System from VISCO JET Rührsysteme GmbH is the result of the so-called cone principle.

Turbulent flows are created at the taper end by acceleration, displacement and retardation. These flows advance through the stirred medium and result in the new dynamic mixing motion

## ➤ Accessories



**Universal stand S2**  
P/N 570-12000-00

- Stand tube Ø: 25 mm
- Length: 700 mm
- Leg distance: 370 mm
- Weight: 5,8 kg



**Stand S2 XXL**  
P/N 570-12200-00

- Stand tube Ø: 25 mm
- Length: 1,000 mm
- Leg distance: 370 mm
- Weight: 6,0 kg



**Telescope stand**  
P/N 570-12100-00

- Stand tube Ø: 32 mm
- Adjustable length: 725 - 1,025 mm
- Leg distance: 370 mm
- Weight: 7,7 kg



**Clamp**  
P/N 570-22000-00

- For stand S2, S2 XXL and telescope stand
- Ø 13-32 mm



**Flex coupling**  
P/N 509-03000-00

- Includes clamping stud for stirrer shaft
- Accepts Ø 10 mm shafts



**Flexible shaft**  
P/N 509-07000-00

- Supplied with chuck



**Stirrer guide (NS 29/32)**  
P/N 509-09000-00

- PTFE with adjustable seal
- Accepts Ø 8 mm shafts



**Shaft guard**  
P/N 509-08100-00

- Material: PMMA
- Incl. adapter set
- Adjusts between 187 mm and 312 mm



**Shaft guard adapter set**  
P/N 11-002-501-02

- For attaching an existing shaft guard to a Hei-TORQUE stirrer



**RS 232 cable (9-pole)**  
P/N 14-007-040-72

- For Hei-TORQUE Precision models

## ➤ Hei-TORQUE Overhead Stirrer Packages

To provide you to the perfect combination for powerful stirring and superior ease of use, we have extended the Hei-TORQUE portfolio with several packages. For an ideal application on laboratory benches each package contains a telescope stand and a clamp.



### Silver Package

P/N 501-61019-00

- Hei-TORQUE Value 100
- Telescope stand
- Clamp

### Gold 1 Package

P/N Nr. 501-61029-00

- Hei-TORQUE Precision 100
- Telescope stand
- Clamp

### Gold 2 Package

P/N Nr. 501-62029-00

- Hei-TORQUE Precision 200
- Telescope stand
- Clamp

### Platinum Package

P/N Nr. 501-64029-00

- Hei-TORQUE Precision 400
- Telescope stand
- Clamp

## Technical Specifications - Overhead Stirrers

Model	RZR 1	Hei-TORQUE Value 100	Hei-TORQUE Value 200	Hei-TORQUE Value 400	Hei-TORQUE Precision 100	Hei-TORQUE Precision 200	Hei-TORQUE Precision 400
P/N (230 V)	501-11000-00	501-61010-00	501-62010-00	501-64010-00	501-61020-00	501-62020-00	501-64020-00
Power rating, motor input/output (W)	77/18	90/50	120/80	150/90	90/50	120/80	150/90
Number of speed gears	2	1	1	2	1	1	2
Direction change of rotation	-	-	-	-	yes	yes	-
Speed range (rpm)	35 - 250 280 - 2,200	10 - 2,000	10 - 2,000	10 - 400 20 - 2,000	10 - 2,000	10 - 2,000	10 - 400 20 - 2,000
Speed indicator	scale	digital monochrom 2.4"	digital monochrom 2.4"	digital monochrom 2.4"	digital color 3.2"	digital color 3.2"	digital color 3.2"
Speed control	mechanic	electronic	electronic	electronic	electronic	electronic	electronic
Torque, maximum (Ncm)	100	100	200	400	100	200	400
Torque indicator	-	symbol	symbol	symbol	precise value	precise value	precise value
Overheat protection	mechanical power limitation	automatic cut-out	automatic cut-out	automatic cut-out	automatic cut-out	automatic cut-out	automatic cut-out
Motor protection	overheat protection	temperature control software	temperature control software	temperature control software	temperature control software	temperature control software	temperature control software
Viscosity, max. (mPa s)	40,000	60,000	100,000	250,000	60,000	100,000	250,000
Stirring cap. (HzO), max. (l)	20	50	50	100	50	50	100
Analog / digital interface	-	-	-	-	USB and RS 232	USB and RS 232	USB and RS 232
Admissible session	continuous operation	continuous operation	continuous operation	continuous operation	continuous operation	continuous operation	continuous operation
Counter/Timer	-	-	-	-	yes	yes	yes
Shaft diameter, max. (mm)	8	10.5	10.5	10.5	10.5	10.5	10.5
Permissible ambient conditions	5 - 31 °C at 80 % rel. humidity 32 - 40 °C decreasing linearly up to max. 50 % rel. humidity	5 - 31 °C at 80 % rel. humidity 32 - 40 °C decreasing linearly up to max. 50 % rel. humidity	5 - 31 °C at 80 % rel. humidity 32 - 40 °C decreasing linearly up to max. 50 % rel. humidity	5 - 31 °C at 80 % rel. humidity 32 - 40 °C decreasing linearly up to max. 50 % rel. humidity	5 - 31 °C at 80 % rel. humidity 32 - 40 °C decreasing linearly up to max. 50 % rel. humidity	5 - 31 °C at 80 % rel. humidity 32 - 40 °C decreasing linearly up to max. 50 % rel. humidity	5 - 31 °C at 80 % rel. humidity 32 - 40 °C decreasing linearly up to max. 50 % rel. humidity
Dimensions (wxhxd) (mm)	71 x 250 x 172	86 X 350 X 247	86 X 350 X 247	93 X 350 X 247	86 X 350 X 247	86 X 350 X 247	93 X 350 X 247
Stay bar size (dia. x l) (mm)	13 x 300	13 x 160	13 x 160	13 x 160	13 x 160	13 x 160	13 x 160
Weight (kg)	2.7	4.4	5.1	5.3	4.4	5.1	5.3
Protection class (DIN EN 60529)	IP 20	IP 54	IP 54	IP 54	IP 54	IP 54	IP 54

Standard supply voltage: 230 V - other voltages upon request, please specify for order

# Certificate

To confirm the ability for  
continuous operation  
of the Hei-TORQUE series Overhead Stirrers

The Hei-TORQUE series Overhead Stirrers feature overtemperature safety circuits according to DIN EN 61010-1:2001 and DIN EN 61010-2-051:2015 and therefore is designed for continuous operation.

This statement is made under the precondition that all units are operated in accordance with the operation manual and in accordance with good practice standards for safety in laboratories, rules for accident preventions, and compliance with directions on hazardous materials.

Schwabach, January 2018



Stefan Peters  
Research and Development Manager



Marcell Sarré  
Quality Manager

# Temperature- Controlled Shaking



## Hei-MIX Shakers & Mixers

Leading Safety Standards

Superior Ease of Use

Reduced Cost of Ownership



Would you love to utilize a complete range of platform shakers which provides you with many possible movements?

## Temperature-Controlled Shaking

Choose from six specific motions - from one to three dimensional movements, from three different load capacities and optional upgrade to an incubator shaker!

- 

3 different load capacities
- 

Different movement amplitudes
- 

Stays in place
- 

Temperature-Controlled
- 

Overheat protection

## Leading Safety Standards

- An **overtemperature sensor** preventively shuts off the unit in a dangerous heat-up situation particularly valuable in case of continuous operation or sensitive research
- Our shaker stays in place **to rule out accidents**: all models have been designed with a low center of gravity which prevents gliding at high speed, including placement on a damp surface
- All platform shakers come with a unique non-skid rubber mat that **prevents vessels from sliding**, including models performing three dimensional movements

## Superior Ease of Use

- Your work requires multiple shaking motions and flask sizes? A large range of shakers and load capacities - from test tube shakers to large multitier platform shakers - serves your needs while **making your life easy with one brand**
- We offer selected accessories and **attachments specific to each model** that best matches your application needs
- **Choose from six specific motions**, from one to three dimensional movements: vibrating, orbital, reciprocating, rocking, wave and overhead rotation
- Within one specific shaking motion, you can even **choose different shaking orbits and angles** to differentiate between soft or rigid shaking
- Choose from three different load capacities of 2, 5 or 10 kg depending on model to **save bench space** or for **high sample throughput**



Clear and self-explanatory front panel layout allows for easy operation

## Reduced Cost of Ownership

- **Increase your sample throughput and reduce your process times** with the modular system for shaking, mixing and heating – all in one
- Are you working with heat-sensitive samples? Platform shakers come with an insulated system to prevent any heat transfer from the motor that could cause potential thermal damage to your sample. **This saves you time and money**
- Maintenance-free motors **reduce repairs and down times** significantly to ensure years of continuous operation backed by the Heidolph 3-year warranty
- The sealed housing on many models protects your shaker from aggressive fumes, liquids and vapors to prevent internal corrosion. This results in an **increased lifespan of 10 years on average** at reduced maintenance and repair costs

# Temperature- Controlled Shaking

Leading Safety Standards

Superior Ease of Use

Reduced Cost of Ownership

## Always the right motion

Our complete range of bench-top shakers provides you with any possible movement for your research.

This makes us the right choice for the right motion of your application

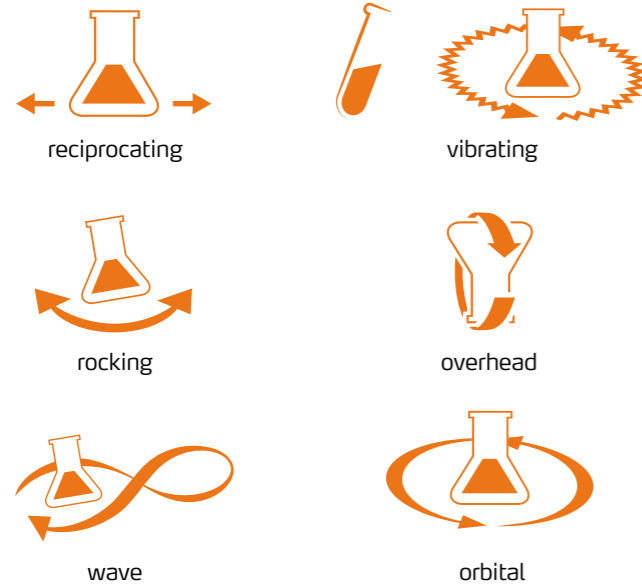

### YOUR ADVANTAGES

- No spills: You can select from a wide range of secure flask attachments for all common vessels and sizes
- No compromise: Shake whatever you want – with this range of products, you will achieve outstanding mixing results, no matter how individualized your process requirement demands
- No limitations: Choose from six specific motions, from one to three-dimensional movements - many models offer options of different orbits and angles to provide increased mixing in the motion range

## Patented optional incubator system

Temperature-controlled shaking is possible simultaneously for each application



### YOUR ADVANTAGES

- Use your limited bench space more efficiently: The modular incubator system comes with the smallest footprint compared to any other common shaker system
- Instantly upgrade your platform shaker to an affordable incubator system using the modular concept
- Full flexibility! No matter how large your vessels are, three incubator hood sizes allow for volumes up to 2-liter Erlenmeyer flasks

The average operational **lifespan of 10 years** is backed by a **3 year warranty** and makes your purchase a worthwhile investment.

An overtemperature sensor **preventively shuts off the unit in a dangerous heat-up situation** – particularly valuable in case of continuous operation

**Rule out accidents:** all models have been designed with a low center of gravity which prevents gliding at high speed, even on a damp surface

**Choose** between different shaking motions, orbits, angles and load capacities: **the right model for your specific application**



Unlimited **visual reaction control** at all times: the transparent, non-fogging PETG material offers it all

**Immediate access:** optional incubator hood opens instantly and interlocks in any position

For applications in microbiology: the insulated drive system **prevents** any heat build-up from the motor and consequently **thermal damage** to your sample

## ➤ Test Tube Shakers – vortexer



Ideal for mixing samples in Eppendorf tubes, vials and similar vessels of different diameters at extremely high speed rates. The ridged mixing orbit yields consistent results and is ideal for product dissolution

### Reax top

#### The standard model

- The **strong 5-mm vibration orbit** yields the best results even **with high viscosity media or solids** out of solution and quickly gives a smooth and even dispersion
- Switch to continuous mode – the unit performs a permanent vibration motion
- Switch to automatic mode - the unit will start once a vessel is pressed to the plate and will stop automatically once this pressure is released
- Fast and dependable mixing results due to high vibration frequency rates up to 2,500 rpm
- Plate for 20-mm diameter test tubes is included as a standard. Test tube tray for flasks up to 50-mm diameter is optionally available in the accessory section



P/N 541-10000-00  
Accessories: Category A



P/N 541-11000-00  
Accessories: Category A

### Reax control

#### The accurate model

- Includes all Reax top features, plus:
- Analog dial speed control with accurate rpm numbers setting
- Improve your results with the electronic speed control that provides constant rpm output even at very low speed and under changing loads

### Multi Reax

#### The all-purpose model

- Unique shaker to accommodate up to 26 vessels with various diameters. Shipment includes as a standard: Attachment for 26 vessels with diameters from 10 to 16 mm  
Attachment for 12 vessels with diameters from 16 to 32 mm
- The **3-mm vibration orbit** allows for excellent mixing results in large and solid samples
- Set and continuously adjust the variable speeds from 150 to 2,000 rpm on the digital display
- A digital process timer allows for unattended operation and can be set from 1 to 999 minutes. When the set time has elapsed, an acoustic alarm will sound and the operation stops



P/N 545-10000-00

## Platform Shakers – vibrating



Do you perform research which requires ridged or gentle shaking for small samples on microtiter plates or test tubes? Five options with different load capacities and shaking orbits are available for you!

### Vibramax 100

#### The compact model

- Vibramax 100 is a compact and space saving unit with a load capacity of 2 kg
- The **3-mm vibration orbit** gives excellent results especially in large vessels – allows for **smooth to ridged** mixing of viscous media and solids
- Set and continuously adjust the variable speed on the analog control knob from 150 to 1,350 rpm
- Optional attachment with tension rollers accepts any glassware size
- A large selection of attachments is provided for the use of various vessels and sizes
- An analog process timer allows for unattended operation and can be set from 1 to 120 minutes. When the set time has elapsed an acoustic alarm will sound and the operation stops



P/N 544-21200-00  
Accessories: Category B



P/N 544-31200-00  
Accessories: Category C

### Vibramax 110

#### The efficient model

- Ideal for the optional attachment to use 49 test tubes that increases your throughput significantly
- The **shaking orbit of 1.5 mm** performs a gentle motion for sensitive samples
- Set and continuously adjust the variable speed on the analog control knob from 150 to 2,500 rpm
- An analog process timer allows for unattended operation and can be set from 1 to 120 minutes. When the set time has elapsed an acoustic alarm will sound and the operation stops

### Titramax

#### Titramax 100 – The compact model

#### Titramax 101 – The strong model

- Titramax 100 is a compact and space-saving unit that accepts load capacities of 2 kg and space for four microtiter plates
- The **1.5-mm vibration orbit** performs **gentle mixing** with best results using small sample volumes. The Titramax 101 has a **3-mm orbit** which was designed for **larger sample volumes**
- Set and continuously adjust the variable speed on the analog control knob from 150 to 1,350 rpm
- An analog process timer allows for unattended operation and can be set from 1 to 120 minutes. When the set time has elapsed an acoustic alarm will sound and the operation stops



Titramax 100 (not shown)  
P/N 544-11200-00

Titramax 101  
P/N 544-11300-00



#### Titramax 1000

P/N 544-12200-00

### Titramax 1000

#### The incubating model

- The use of six microtiter plates increases your throughput by 50 %
- The **1.5-mm vibration orbit** performs gentle mixing with best results using small sample volumes
- Titramax 1000 is a medium-sized model and accepts load capacities of 5 kg
- This model is suitable for the modular incubator system and is recommended for applications which require variable temperature control up to 65 °C
- Set and continuously adjust the variable speed on the analog control knob from 150 to 1,350 rpm
- An analog process timer allows for unattended operation and can be set from 1 to 120 minutes. When the set time has elapsed an acoustic alarm will sound and the operation stops

### Titramax Package

#### This package includes:

- One vibrating platform shaker Titramax 1000
- One heating module and
- One flat incubator hood

P/N 544-12209-00



## Platform Shakers – orbital



### Time and tranquility are required for the cultivation of cells

The slow and constant rotation of the Rotamax and Unimax models keeps your samples continuously in motion



#### Rotamax 120

##### The compact model

- Rotamax 120 is a compact and space-saving unit that accepts load capacities of 2 kg
- Wide range of accessories, attachments and clamps for up to 16 Erlenmeyer flasks available
- The shaking **orbit of 20 mm** performs a gentle motion for sensitive samples and supports culture plates and Erlenmeyer flasks
- Set and continuously adjust the variable speed on the analog control knob from 20 to 300 rpm
- An analog process timer allows for unattended operation and can be set from 1 to 120 minutes. When the set time has elapsed an acoustic alarm will sound and the operation stops

P/N 544-41200-00  
Accessories: Category B

#### Unimax 1010

##### The incubating model

- The Unimax 1010 is a medium sized model and accepts load capacities of 5 kg
- The shaking **orbit of 10 mm** performs a gentle motion for sensitive samples and supports culture plates and Erlenmeyer flasks
- Set and continuously adjust the variable speed on the digital display from 30 to 500 rpm
- This model is suitable for the modular incubator system and is recommended for applications which require variable temperature control up to 65 °C
- An digital process timer allows for unattended operation and can be set from 1 to 999 minutes. When the set time has elapsed an acoustic alarm will sound and the operation stops



P/N 543-12310-00  
Accessories: Category D



P/N 542-10020-00  
Accessories: Category E

#### Unimax 2010

##### The resilient model

- The Unimax 2010 is a large model and accepts a load capacity of 10 kg for high sample throughput
- The shaking **orbit of 20 mm** performs a gentle motion for sensitive samples and supports culture plates and Erlenmeyer flasks
- Set and continuously adjust the variable speed on the digital display from 20 to 400 rpm
- Increase your sample throughput with the optional multi-tier attachment for a variety of vessel sizes
- An analog process timer allows for unattended operation and can be set from 1 to 120 minutes. When the set time has elapsed an acoustic alarm will sound and the operation stops

#### Unimax Package

##### This package includes:

- One orbital platform shaker Unimax 1010
- One heating module and
- One high incubator hood

P/N 543-12319-00





## ➤ Platform Shakers – rocking

Focus on cell culture, mix in large media bottles and require a two-dimensional motion with flexibility to heat? The Duomax is available in two different angle configurations which are recommended for culture plates/bottles, media bottles and Erlenmeyer flasks to help cultivate cells



### Duomax 1030

#### The incubating model

- The Duomax 1030 is a medium-sized model and accepts load capacities of 5 kg
- Choose your angle between these two options: **tilt angle of 5°** for soft and gentle movements or tilt angle **of 10°** for a much stronger motion
- Set and continuously adjust the variable speed on the analog control knob from **2 to 50 rpm** – ideal for media bottles
- This model is suitable for the modular incubator system and is recommended for applications which require variable temperature control up to 65 °C
- An analog process timer allows for unattended operation and can be set from 1 to 120 minutes. When the set time has elapsed an acoustic alarm will sound and the operation stops

Features tilt angle of 5° P/N 543-32205-00  
Features tilt angle of 10° P/N 543-32210-00  
Accessories: Category D

## ➤ Platform Shakers - reciprocating

Are you missing the right shaker for separations in chemistry or for the performance of soil tests? All Promax models are designed especially for phase separations using separatory funnels or applications that require reciprocating motion!

### Promax 1020

#### The incubating model

- The Promax 1020 is a medium-sized model and accepts load capacities of 5 kg
- Wide range of accessories, attachments and clamps for separatory funnels available
- With a **stroke length of 32 mm** the Promax model performs an ideal motion for separatory funnels
- Set and continuously adjust the variable speed on the digital display from **30 to 250 rpm**
- This model is suitable for the modular incubator system and is recommended for applications which require variable temperature control up to 65 °C
- An digital process timer allows for unattended operation and can be set from 1 to 999 minutes. When the set time has elapsed an acoustic alarm will sound and the operation stops



P/N 543-22332-00  
Accessories: Category D



P/N 542-20020-00  
Accessories: Category E

### Promax 2020

#### The resilient model

- The Promax 2020 is a large model and accepts a load capacity of 10 kg for high sample throughput
- With a **stroke length of 20 mm** this Promax model can mix larger volumes with ease
- Set and continuously adjust the variable speed on the digital display from **20 to 400 rpm** – ideal for separations
- Wide range of accessories, attachments and clamps for separatory funnels available
- An analog process timer allows for unattended operation and can be set from 1 to 120 minutes. When the set time has elapsed an acoustic alarm will sound and the operation stops

## ➤ Platform Shakers – wave

Nothing beats a three-dimensional motion: For best mixing results of viscous media such as gels for electrophoresis, you can also choose the tilt angle that works best for the application



Features tilt angle of 5° P/N 543-42205-00  
Features tilt angle of 10° P/N 543-42210-00  
Accessories: Category D

### Polymax 1040

#### The incubating model

- The Polymax 1040 is a medium-sized model and accepts **load capacities of 5 kg**
- Choose your angle between these two options: tilt angle of 5° for soft and gentle movements or tilt angle of 10° for a much stronger motion
- Use this model for any vessel – from culture plates and media bottles to Erlenmeyer flasks – there is no limit
- Set and continuously adjust the variable speed on the analog control knob from **2 to 50 rpm** – ideal for cell culture plates
- This model is suitable for the modular incubator system and is recommended for applications which require variable temperature control up to 65 °C
- An analog process timer allows for unattended operation and can be set from 1 to 120 minutes. When the set time has elapsed an acoustic alarm will sound and the operation stops

### Polymax 2040

#### The resilient model

- The Polymax 2040 is a large model and accepts a **load capacity of 10 kg** for high sample throughput
- Choose your angle between these two options: tilt angle of 5° for soft and gentle movements or tilt angle of 10° for a much stronger motion
- Use this model for any vessel – from culture plates and media bottles to Erlenmeyer flasks – there is no limit
- Set and continuously adjust the variable speed on the digital display from **2.5 to 50 rpm** – ideal for cell culture plates
- An analog process timer allows for unattended operation and can be set from 1 to 120 minutes. When the set time has elapsed an acoustic alarm will sound and the operation stops



Features tilt angle of 5° P/N 542-40005-00  
Features tilt angle of 10° P/N 542-40010-00  
Accessories: Category E

## ➤ Incubator 1000

**Your platform shaker has no space in your heating oven or incubator cabinet? Adjustable temperature and visual control are key priorities for you?**

This truly unique system enables you to perform a number of functions simultaneously - shaking, mixing and heating with visual reaction control. These platform shakers are compatible with the incubator system: Duomax 1030, Polymax 1040, Titramax 1000, Unimax 1010 and Promax 1020



#### YOUR ADVANTAGES

- Heating module allows for **gentle temperature** adjustments up to 65 °C
- The electrical heater allows for quick and **even temperature distribution** throughout the entire enclosure
- Unlimited **visual reaction control** at all times: the transparent and non-fogging PETG construction offers it all
- **Three options available:** a flat hood for small vessels and microtiter plates, a high hood for all common medium-sized vessels and even a high hood XL for larger Erlenmeyer flasks up to 2,000 ml
- **Immediate access:** the incubator hood opens instantly and interlocks in any position
- **Use ONE incubator for numerous shakers** - interchangeability is ensured and takes less than 2 minutes. You can incubate and mix simultaneously or independently

### Heating module

- **Heating capacity of 300 W** allows for quick temperature adjustments
- Digital temperature settings **up to 65 °C** and separate display for actual temperature
- To protect your sample from thermal damages this unit features a safety circuit to **prevent overheating**
- Electrical heater comes with **low-noise blower** and provides accuracy of ± 2 °C up to 50 °C and ± 4 °C over 50 °C



P/N 549-90010-00

## ➤ Incubator 1000

### Incubator hoods

Combine the heating module with an incubator hood of your choice:

#### Flat hood

##### For small vessels

- The small incubator hood has a total **height of 163 mm**
- Recommended especially for microtiter plates, culture plates, small flasks, media bottles and Erlenmeyer flasks **up to 100 ml**
- Transparent and non-fogging PETG material allows for sample viewing and easy cleaning



**Flat hood**  
P/N 549-90040-00



**High hood**  
P/N 549-90030-00

#### High hood XL

##### For 2,000-ml vessels

- The high hood XL has a total **height of 428 mm**
- Recommended especially for **2,000-ml** Erlenmeyer flasks
- Transparent and non-fogging PETG material allows for sample viewing and easy cleaning



**High hood XL**  
P/N 549-90060-00

## ➤ Overhead Shakers



Complies with standards for the determination of elutriation with water



### Reax 20

#### Overhead shakers for 4, 8 or even 12 bottles

- Set and continuously adjust the variable speed on the analog control knob from **1 to 16 rpm** – ideal for waste water analysis
- A model with a rotation speed of 2 to 32 rpm is available upon request
- Easy and fast attachments of bottles
- Other vessels with **160 - 270-mm** height and max. 136-mm diameter can be used with attachments

**Reax 20/4** (not shown)  
P/N 541-20004-00  
Accessories: Category G

**Reax 20/8**  
P/N 541-20008-00  
Accessories: Category G

**Reax 20/12** (not shown)  
P/N 541-20012-00  
Accessories: Category G

### Reax 2

- Quickly clamps in 2 vessels of any size and accepts load capacities up to 1 kg
- Speed continuously adjustable from **20 to 100 rpm**
- Universal adaptor allows for the use of various vessels of **50 - 160-mm height**
- In addition, an optional adaptor is available for the use of 20 test tubes at a time



P/N 541-21009-00  
Accessories: Category F

## Accessories



**A**  
**Test tube tray, large**  
For test tubes and flasks up to 50 ml  
P/N 549-19000-00



**A**  
**Test tube holding device**  
Attachment to hold one test tube safely for continuous shaking  
P/N 549-20000-00



**A**  
**Attachment for 10 test tubes**  
For up to 10 test tubes with Ø 10 mm, length up to 60 mm  
P/N 549-01000-00

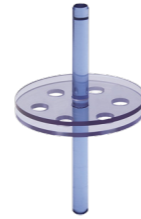

**A**  
**Test tube stand**  
For up to 6 Eppendorf vessels (1.5 ml)  
P/N 549-04000-00



**D**  
**Frame with tension roller**  
Attachment with 2 tension rollers  
P/N 549-70000-00



**D**  
**Spare tension roller**  
1 tension roller as accessory for attachment  
P/N 549-70000-00  
P/N 549-71000-00



**E**  
**Perforated platform 2000**  
Universal perforated platform allows for individual arrangement of vessels  
P/N 549-59000-00



**E**  
**Frame tension roller**  
Frame without tension roller  
P/N 549-50000-00



**B**  
**Tension roller attachment**  
Attachment with 2 tension rollers  
P/N 549-81000-00



**B**  
**Spare tension roller**  
1 tension roller for attachment  
P/N 549-81000-00  
P/N 11-008-007-08



**B**  
**Perforated platform 100**  
Universal perforated platform allows for individual arrangement of vessels  
P/N 549-59100-00



**C**  
**Test tube attachment**  
For up to 49 test tubes with Ø 12 mm, length up to 80 mm  
P/N 549-82000-00

For up to 36 test tubes with Ø 16 mm, length up to 80 mm  
P/N 549-83000-00



**E**  
**Tension roller**  
1 tension roller for the frame  
P/N 549-50000-00, please order 2 pcs. min.  
P/N 549-58000-00



**E**  
**Multi-tier attachment**  
Includes perforated platform 2000 and 4 supporting rods  
P/N 549-62000-00

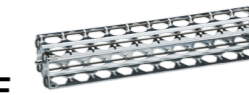

**F**  
**Adaptor for 20 test tubes**  
Allows for simultaneously mixing 20 test tubes Ø 10-18 mm with just one shaker  
P/N 549-21000-00



**G**  
**Tension plate for caps**  
Allows for the use of common bottles with Ø 94 mm  
P/N 11-001-001-81



**D**  
**25-ml Erlenmeyer attachment**  
Attachment for up to 22 Erlenmeyer flasks with a size of 25 ml  
P/N 549-72000-00



**D**  
**50-ml Erlenmeyer attachment**  
Attachment for up to 14 Erlenmeyer flasks with a size of 50 ml  
P/N 549-73000-00



**D**  
**100-ml Erlenmeyer attachment**  
Attachment for up to 9 Erlenmeyer flasks with a size of 100 ml  
P/N 549-74000-00



**D**  
**250-ml Erlenmeyer attachment**  
Attachment for up to 5 Erlenmeyer flasks with a size of 250 ml  
P/N 549-75000-00



**G**  
**Attachment for 0.5-l bottles**  
(Set of 4) Allows for the use of four 0.5-l bottles  
P/N 549-27000-00



**G**  
**Attachment for 1-l bottles**  
(Set of 4) Allows for the use of four 1-liter bottles  
P/N 549-26000-00

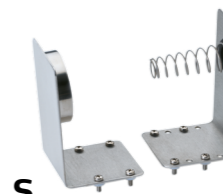

**S**  
**Separatory funnel clamp (250 ml, 500 ml, 1000 ml)**  
For perforated platform 2000, space for max. 4 (250 ml), 3 (500 ml) or 3 (1000 ml) clamps  
P/N 549-57000-00

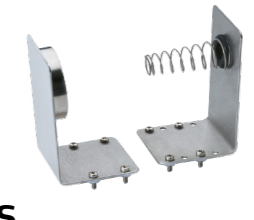

**S**  
**Separatory funnel clamp (2000 ml)**  
For perforated platform 2000, space for max. 2 clamps  
P/N 549-61000-00



**D**  
**500-ml Erlenmeyer attachment**  
Attachment for up to 4 Erlenmeyer flasks with a size of 500 ml  
P/N 549-76000-00



**D**  
**1000-ml Erlenmeyer attachment**  
Attachment for up to 2 Erlenmeyer flasks with a size of 1000 ml  
P/N 549-77000-00

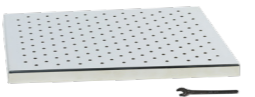

**D**  
**Perforated platform 1000**  
Universal perforated platform allows for individual arrangement of vessels  
P/N 549-59200-00

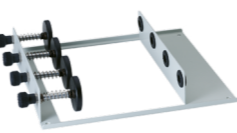

**D**  
**Separatory funnel attachment**  
Attachment for 4 separatory funnels (50 ml, conical) or 4 separatory funnels (100 ml, conical)  
P/N 549-78000-00

### Accessories for:

- A** Reax top/control
- B** Vibramax 100, Rotamax 120
- C** Vibramax 110
- D** Unimax 1010, Duomax 1030, Polymax 1040, Promax 1020

- E** Unimax 2010, Promax 2020, Polymax 2040
- F** Reax 2
- G** Reax 20/4 · 20/8 · 20/12
- S** Additional Accessories for Shakers & Mixers

### S - Clamps for the perforated platform 100, 1000 and 2000

	For 25-ml Erlenmeyer flasks Size 1	For 50-ml Erlenmeyer flasks Size 2	For 100-ml Erlenmeyer flasks Size 3	For 250-ml Erlenmeyer flasks Size 4	For 500-ml Erlenmeyer flasks Size 5	For 1000-ml Erlenmeyer flasks Size 6	For 2000-ml Erlenmeyer flasks Size 7
 P/N	549-51000-00	549-52000-00	549-53000-00	549-54000-00	549-55000-00	549-56000-00	549-63000-00
<b>For platform 100</b>	max. 16	max. 16	max. 8	max. 5	max. 3	max. 2	-
<b>For platform 1000</b>	max. 20	max. 20	max. 14	max. 8	max. 4	max. 4	max. 2
<b>For platform 2000</b>	max. 36	max. 36	max. 23	max. 12	max. 9	max. 5	max. 3

## Technical Specifications - Shakers and Mixers

Model	Reax top	Reax control	Multi Reax	Titramax 100	Titramax 101	Titramax 1000	Vibramax 100	Vibramax 110	Rotamax 120
Motion	vibrating	vibrating	vibrating	vibrating	vibrating	vibrating	vibrating	vibrating	orbital
Rotation speed (rpm)	0 – 2,500	0 – 2,500	150 – 2,000	150 – 1,350	150 – 1,350	150 – 1,350	150 – 1,350	150 – 2,500	20 – 300
Rotation speed setting	analog	analog	digital	electronic contr.	electronic contr.	electronic contr.	electronic contr.	electronic contr.	electronic contr.
Orbit (mm)	5	5	3	1.5	3	1.5	3	1.5	20
Operating mode	automatic or continuous	automatic or continuous	timer or continuous	timer or continuous	timer or continuous	timer or continuous	timer or continuous	timer or continuous	timer or continuous
Input power (W)	51	51	50	31	31	31	31	46	33
Weight (kg)	2.8	2.8	9.8	5.5	5.5	6.5	5.5	12.2	5.5
Dimensions (w x h x d) (mm)	134 x 105 x 172	134 x 105 x 172	270 x 172 x 410	245 x 125 x 310	245 x 125 x 310	320 x 125 x 375	245 x 125 x 310	245 x 146 x 310	245 x 125 x 310
Platform size (mm)	–	–	–	220 x 220	220 x 220	290 x 258	220 x 220	140 x 140	220 x 220
Accessories included	–	–	2 carousel attachments	space for 4 microtiter plates	space for 4 microtiter plates	space for 6 microtiter plates	non-skid rubber mat	non-skid rubber mat	non-skid rubber mat
Load capacity (kg)	–	–	1.5	2	2	5	2	2	2
Overheat protection	self-resetting	self-resetting	self-resetting	self-resetting	self-resetting	self-resetting	self-resetting	self-resetting	self-resetting
Permissible ambient conditions	5 – 31 °C at 80 % rel. humidity 32 – 40 °C decreasing linearly up to max. 50 % rel. humidity	5 – 31 °C at 80 % rel. humidity 32 – 40 °C decreasing linearly up to max. 50 % rel. humidity	5 – 31 °C at 80 % rel. humidity 32 – 40 °C decreasing linearly up to max. 50 % rel. humidity	5 – 31 °C at 80 % rel. humidity 32 – 40 °C decreasing linearly up to max. 50 % rel. humidity	5 – 31 °C at 80 % rel. humidity 32 – 40 °C decreasing linearly up to max. 50 % rel. humidity	5 – 31 °C at 80 % rel. humidity 32 – 40 °C decreasing linearly up to max. 50 % rel. humidity	5 – 31 °C at 80 % rel. humidity 32 – 40 °C decreasing linearly up to max. 50 % rel. humidity	5 – 31 °C at 80 % rel. humidity 32 – 40 °C decreasing linearly up to max. 50 % rel. humidity	5 – 31 °C at 80 % rel. humidity 32 – 40 °C decreasing linearly up to max. 50 % rel. humidity
Protection class (DIN EN 60529)	IP 22	IP 22	IP 30	IP 30	IP 30	IP 30	IP 30	IP 30	IP 30

Model	Unimax 1010	Unimax 2010	Promax 1020	Promax 2020	Duomax 1030	Polymax 1040	Polymax 2040	Reax 2	Reax 20/4 Reax 20/8 Reax 20/12
Motion	orbital	orbital	reciprocating	reciprocating	rocking	wave	wave	overhead	overhead
Rotation speed (rpm)	30 – 500	20 – 400	30 – 250	20 – 400	2 – 50	2 – 50	2.5 – 50	20 – 100	1 – 16
Rotation speed setting	digital	digital	digital	digital	electronic contr.	electronic contr.	digital	analog	electronic contr.
Orbit / Stroke (mm)	10	20	32	20	–	–	–	–	–
Angle (°)	–	–	–	–	5/10	5/10	5/10	–	–
Operating mode	timer or continuous	timer or continuous	timer or continuous	timer or continuous	timer or continuous	timer or continuous	timer or continuous	–	–
Input power (W)	50	115	50	115	115	115	115	27	280
Weight (kg)	8.0	16	8.0	16	8.0	8.0	16	5.2	23, 28, 33
Dimensions (w x h x d) (mm)	320 x 125 x 375	426 x 135 x 435	320 x 125 x 375	426 x 135 x 435	320 x 185 x 375	320 x 195 x 375	426 x 208 x 435	510 x 180 x 235	Reax 20/4 490 x 465 x 520 Reax 20/8 770 x 465 x 520 Reax 20/12 1050 x 465 x 520
Platform size (mm)	290 x 258	390 x 340	290 x 258	390 x 340	290 x 258	290 x 258	390 x 340	–	
Accessories included	non-skid rubber mat	non-skid rubber mat	non-skid rubber mat	non-skid rubber mat	non-skid rubber mat	non-skid rubber mat	non-skid rubber mat	universal adaptor	
Load capacity (kg)	5	10	5	10	5	5	10	1	30
Overheat protection	self-resetting	self-resetting	self-resetting	self-resetting	self-resetting	self-resetting	self-resetting	self-resetting	self-resetting
Permissible ambient conditions	5 – 31 °C at 80 % rel. humidity 32 – 40 °C decreasing linearly up to max. 50 % rel. humidity	5 – 31 °C at 80 % rel. humidity 32 – 40 °C decreasing linearly up to max. 50 % rel. humidity	5 – 31 °C at 80 % rel. humidity 32 – 40 °C decreasing linearly up to max. 50 % rel. humidity	5 – 31 °C at 80 % rel. humidity 32 – 40 °C decreasing linearly up to max. 50 % rel. humidity	5 – 31 °C at 80 % rel. humidity 32 – 40 °C decreasing linearly up to max. 50 % rel. humidity	5 – 31 °C at 80 % rel. humidity 32 – 40 °C decreasing linearly up to max. 50 % rel. humidity	5 – 31 °C at 80 % rel. humidity 32 – 40 °C decreasing linearly up to max. 50 % rel. humidity	5 – 31 °C at 80 % rel. humidity 32 – 40 °C decreasing linearly up to max. 50 % rel. humidity	5 – 31 °C at 80 % rel. humidity 32 – 40 °C decreasing linearly up to max. 50 % rel. humidity
Protection class (DIN EN 60529)	IP 40	IP 20	IP 40	IP 20	IP 40	IP 40	IP 20	IP 21	IP 21

Standard supply voltage: 230 V - other voltages upon request, please specify for order

# Certificate

To confirm the ability for  
continuous operation  
of the Test Tube and Platform Shakers

The Test Tube and Platform Shakers feature overtemperature safety circuits according to DIN EN 61010-1:2001 and DIN EN 61010-2-051:2015 and therefore is designed for continuous operation.

This statement is made under the precondition that all units are operated in accordance with the operation manual and in accordance with good practice standards for safety in laboratories, rules for accident preventions, and compliance with directions on hazardous materials.

Schwabach, January 2018



Stefan Peters  
Research and Development Manager



Marcell Sarré  
Quality Manager

# Precise Dosing and Dispensing



## Hei-FLOW Peristaltic Pumps

Leading Safety Standards

Superior Ease of Use

Reduced Cost of Ownership



Are you in need of a system that provides the most accurate pumping and dosing of aggressive, corrosive or even sterile media without any compromise to precision?

## Precise Dosing and Dispensing

The versatile Hei-FLOW series can offer you all these options with flow rates ranging from 0.005 to 4,151 ml per minute depending on configuration!

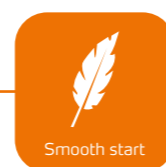
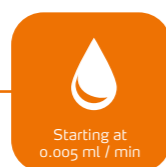

## Leading Safety Standards

- Important for continuous unattended operation: the motor will be switched off if a high thermal load situation occurs to increase safety in your lab and to **prevent accidents**
- Protection class IP 55 protects your unit from highly aggressive vapors or liquids – and thus **eliminates accidents, short-circuits and failures**
- Additional safety is provided by sparkless motors which **reduce incidents**
- Use an optional foot-pedal remote control via cable to start and stop your pump drive outside a **closed fume hood increasing your personal safety**
- All models feature a smooth start operation that **prevents spilling and splashing of media**. The speed will ramp up slowly until your set rpm has been reached
- The pumped media remains in the tubing and never comes in contact with you – keeping you and **your application safe**

## Superior Ease of Use

- The Hei-FLOW series is **self-priming** and **comes without any valves**, thus providing care-free operation
- Use a single-channel pump head and **upgrade your model** to multi-channel operation in just minutes with a different pump head
- Analog and digital interfaces **facilitate operation**, e.g. by connecting the optional foot-pedal
- Our clear and **self-explanatory front panel** layout is for your ease of operation
- Use your valuable lab space efficiently and stack one pump on top of the other to build a space-saving **two-layer system**
- Make your life easier and rely on the **accurate liquid delivery** starting from 0.005 ml/min

## Reduced Cost of Ownership

- Reduce your maintenance costs: the sealed housing protects your pump from aggressive fumes, liquids and vapors to prevent internal corrosion. This results in an increased **lifespan of 10 years** on average while reducing maintenance and repair cost
- Complete packages including pump drive, head and compatible tubing reduce your selection process and give you a **reduced package price**
- Maintenance-free motors **eliminate repairs and down times** to ensure years of continuous operation

# Precise Dosing and Dispensing



Leading Safety Standards

Superior Ease of Use

Reduced Cost of Ownership

The average operational **lifespan of 10 years** is backed by a **3 year warranty** and makes your purchase a worthwhile investment.

Safety for continuous operation: the motor will be switched off if a high thermal load situation occurs to **prevent accidents**

**Protection class IP 55** to prevent corrosion and short circuits

**High precision** even for flow rates starting at 0.005 ml/min

Optional foot-pedal remote control via cable to operate pump drive from **outside closed fume hoods** facilitate operation

For the use in cell biology just use a pump head which features convex rollers and **does not squeeze** the tubing as conventional rollers



All models feature a smooth start operation which **prevents spills and splashing media**. The speed will ramp up slowly until your set rpm has been reached

## Precise dosing and dispensing

Are you in need of a system that provides the most accurate pumping and dosing of aggressive, corrosive or even sterile media without any compromise to precision?

The versatile Hei-FLOW series offers you all these options - with flow rates ranging from 0.005 to 4,151 ml per minute depending on configuration



### YOUR ADVANTAGES

- If you are looking for standard pumping or highly accurate interval dosing and interval operation allowing for standstills and filling of flasks, the Hei-FLOW series has it all
- Your application media never comes in contact with the pump head – eliminating cross-contamination and the need to clean the unit between projects
- The pumped media remains in the tubing and never comes in contact with you – keeping you and your application safe
- The versatile Hei-FLOW series offers you all these options - with flow rates ranging from 0.005 to 4,151 ml per minute depending on configuration
- Choose from six different pump drives, three pump heads for single-channel use, and three additional pump heads for multi-channel use that can accommodate up to twelve cassettes

## Pump heads

Are you engaged in a highly specialized application such as cell biology and do you need to transfer the cells without causing damage?

The Hei-FLOW series offers you solutions for standard applications and highly sophisticated challenges that require added control!

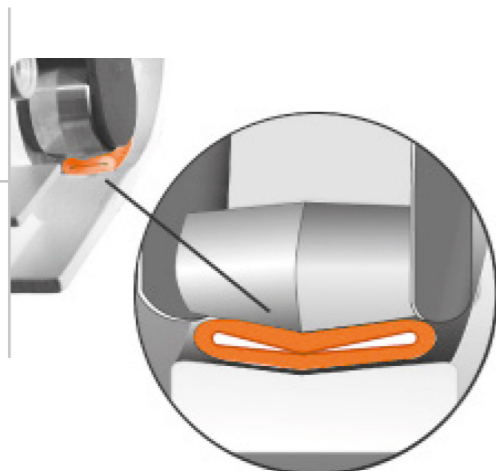

### YOUR ADVANTAGES

- For the use in cell biology, choose a pump head which features convex rollers that do not squeeze the tubing, as would conventional rollers
- Consequently, organic cell cultures are not crushed and your samples are safely transported
- A wide range of tubing material is available – choose the most appropriate material for your research: whether FDA-approved material for food analysis or material for aggressive media such as acids – you find it right here



## ➤ Hei-FLOW Value 01 / Hei-FLOW Value 06

### For standard applications and liquid transfer

Pumps include leading safety standards and features for superior ease of use and reduced cost of ownership, plus:

- Adjust the variable speed from 10 - 600 rpm on the analog control knob. **Your speed is held constant** even under changing loads
- These models feature electronic speed control at an **accuracy rate of  $\pm 2\%$**
- At the press of a button the pump operates **clockwise or counter-clockwise**



### Hei-FLOW Value 01

Flow rates of 0.85 - 861 ml/min with single-channel pump heads

- Low speed range from 10 - 120 rpm
- This pump drive is suitable for multi-channel operation
- Multi-channel flow rates from 0.005 - 364 ml/min
- Upgrade your Hei-FLOW Value 01 for multi-channel operation in just minutes with a pump head adaptor: P/N 526-16000-00

#### Hei-FLOW Value 01

P/N 523-50010-00

#### Hei-FLOW Value 01 Multi

(incl. adapter for multi-channel pumps heads)

P/N 523-50013-00

### Hei-FLOW Value 06

Flow rates of 4.0 - 4,151 ml/min with single-channel pump heads

- High speed range from 50 - 600 rpm
- This pump drive is not suitable for multi-channel operation

#### Hei-FLOW Value 06

P/N 523-50060-00

## ➤ Hei-FLOW Advantage 01 / Hei-FLOW Advantage 06

### For reproducible results and liquid transfer

Pumps include leading safety standards and features for superior ease of use and reduced cost of ownership, plus:

- Control speed (rpm), direction and On/Off function via **analog interface** for 0 - 10 V or 4 - 20 mA
- Adjust the variable speed from 5 - 600 rpm on the analog control knob. **Your speed is held constant** even under changing loads
- These models feature electronic speed control at an **accuracy of  $\pm 0.5\%$**
- These models connect to an optional foot-pedal **remote control** via cable to start and stop your pump drive outside a closed fume hood increasing your personal safety and superior ease of use in multiple sample fills
- A press of the max button **accelerates the filling and draining** of your tube
- At the press of a button the pump operates **clockwise or counter-clockwise**



### Hei-FLOW Advantage 01

Flow rates of 0.38 - 813 ml/min with single-channel pump heads

- Low speed range from 5 - 120 rpm
- This pump drive is suitable for multi-channel operation
- Multi-channel flow rates from 0.005 - 329 ml/min
- Upgrade your Hei-FLOW Advantage 01 for multi-channel operation in just minutes with a pump head adaptor: P/N 526-16000-00

#### Hei-FLOW Advantage 01

P/N 523-51010-00

#### Hei-FLOW Advantage 01 Multi

(incl. adapter for multi-channel pumps heads)

P/N 523-51013-00

### Hei-FLOW Advantage 06

Flow rates of 2.0 - 4,056 ml/min with single-channel pump heads

- High speed range from 24 - 600 rpm
- This pump drive is not suitable for multi-channel operation

#### Hei-FLOW Advantage 06

P/N 523-51060-00

## ➤ Hei-FLOW Precision 01 / Hei-FLOW Precision 06

### Reproducibility - pumping and dosing

Pumps include leading safety standards and features for superior ease of use and reduced cost of ownership, plus:

- Control speed (rpm), direction and On/Off function via **analog interface** for 0 - 10 V or 4 - 20 mA or digital **RS 232 interface**
- These models connect to an optional foot-pedal **remote control** via cable to start and stop your pump drive outside a closed fume hood increasing your personal safety and superior ease of use in multiple sample fills
- These models feature electronic speed control at an **accuracy of ± 0.5 %**
- A press of the max button **accelerates the filling and draining** of your tube
- At the press of a button the pump operates **clockwise or counter-clockwise**
- Calibrate** your flow volume and flow rate individually
- Flow characteristic** of pump heads in combination with various tubing diameters is **pre-programmed** for accurate flow rate numbers
- Digital read-out of:**
  - Speed (rpm)
  - Tubing diameter
  - Flow rate in ml/min
  - Dosing volume
  - Interval dosing
  - Pause function
- Easily change** all process parameters via control buttons



### Hei-FLOW Precision 01

Flow rates of 0.38 - 813 ml/min with single-channel pump heads

- Low speed range from 5 - 120 rpm
- This pump drive is suitable for multi-channel operation
- Multi-channel flow rates from 0.005 - 364 ml/min
- Upgrade your Hei-FLOW Precision 01 for multi-channel operation in just minutes with a pump head adaptor: P/N 526-16000-00

#### Hei-FLOW Precision 01

P/N 523-52010-00

#### Hei-FLOW Precision 01 Multi

(incl. adapter for multi-channel pumps heads)

P/N 523-52013-00

### Hei-FLOW Precision 06

Flow rates of 2.0 - 4.056 ml/min with single-channel pump heads

- High speed range from 24 - 600 rpm
- This pump drive is not suitable for multi-channel operation

#### Hei-FLOW Precision 06

P/N 523-52060-00

## ➤ Single-Channel Pump Heads

### SP quick

- Fast and convenient tube changes
- Low pulsation due to 5 roller system
- Pump head features ball bearings
- Rollers made of stainless steel
- For tubes with a 1.6-mm or 2.5-mm wall thickness (wt)
- Depending on drive and tubing, flow rate ranges from 0.38 to 3.436 ml per minute



#### SP quick

P/N 527-11100-00 (wt 1.6 mm)

P/N 527-11300-00 (wt 2.5 mm)

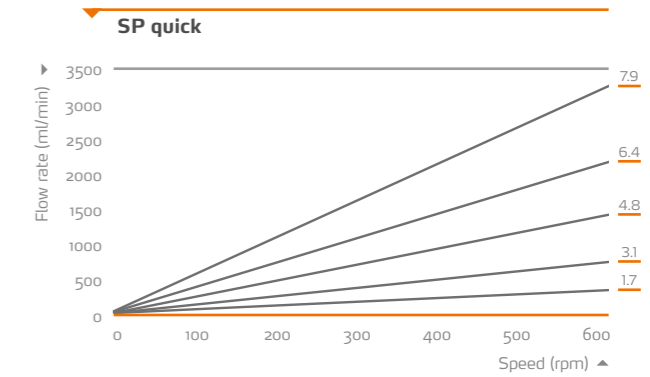

### SP standard

- Recommended for standard applications
- Convex rollers do not squeeze or crush organic cell cultures
- Pump head features ball bearings
- Rollers made of stainless steel and polyamide
- For tubes with a 1.6-mm or 2.5-mm wall thickness (wt)
- Depending on drive and tubing, the flow rate ranges from 2.0 to 4.151 ml per minute



#### SP standard

P/N 523-43010-00 (wt 1.6 mm)

P/N 523-43030-00 (wt 2.5 mm)



#### SP vario

P/N 523-45110-00

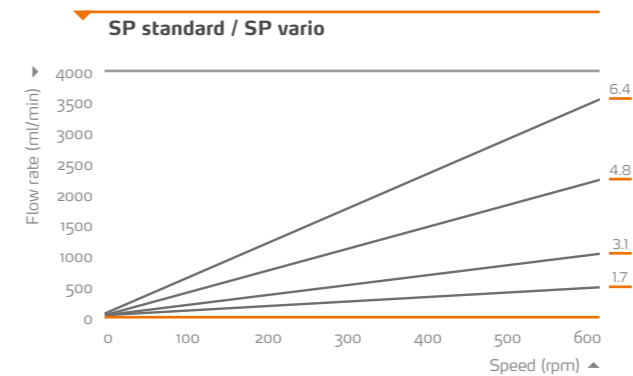

### SP vario

- Suitable for most Heidolph tubing due to adjustable roller spacing
- Convex rollers do not squeeze or crush organic cell cultures
- Pump head features ball bearings
- Rollers made of stainless steel and aluminum
- Depending on drive and tubing, the flow rate ranges from 2.0 to 4.151 ml per minute



+



+







=

Single-channel pump

## ▶ Tubing Sizes for Single-Channel Pumps

### Tubing sizes

						
Inner diameter	(mm)	0.8	1.7	3.1	4.8	6.4
Outer diameter	(mm)	4	4.9	6.3	8	9.5
<b>Wall thickness (wt)</b>	<b>(mm)</b>	<b>1.6</b>	<b>1.6</b>	<b>1.6</b>	<b>1.6</b>	<b>1.6</b>
Max. pressure (continuous / short time)	(bar)	0.7 / 1.7	0.7 / 1.7	0.7 / 1.7	0.5 / 1.5	0.5 / 1.5
Suction height	(mH <sub>2</sub> O)	8.8	8.8	8.8	8.8	6.7



### Average flow rates in combination with pump head and pump drive:

SP quick		0.8		1.7		3.1		4.8		6.4	
		min.	max.	min.	max.	min.	max.	min.	max.	min.	max.
Hei-FLOW Advantage o6 / Hei-FLOW Precision o6	(ml/min)	2	33	8	186	26	653	59	1,529	89	2,072
Hei-FLOW Value o6	(ml/min)	4	35	17	197	57	695	123	1,494	186	1,765
Hei-FLOW Advantage o1 / Hei-FLOW Precision o1	(ml/min)	0.38	9	2	40	5	126	12	233	17	409
Hei-FLOW Value o1	(ml/min)	0.83	9	3	41	11	134	25	292	36	413
SP standard / SP vario				min.		max.		min.		max.	
Hei-FLOW Advantage o6 / Hei-FLOW Precision o6	(ml/min)			11	257	43	1,017	105	2,549	167	4,056
Hei-FLOW Value o6	(ml/min)			22	249	93	1,037	228	2,613	364	4,151
Hei-FLOW Advantage o1 / Hei-FLOW Precision o1	(ml/min)			2	55	9	221	21	530	33	813
Hei-FLOW Value o1	(ml/min)			5	61	19	223	44	519	75	861

### Tubing P/N (per meter):

Silicone	525-33000-00	525-34000-00	525-36000-00	525-30027-00	525-30028-00
Viton®	525-53000-00	525-54000-00	525-56000-00	525-50027-00	525-50028-00
PharMed®	525-23000-00	525-24000-00	525-26000-00	525-20027-00	525-20028-00
Tygon® (standard)	525-63000-00	525-64000-00	525-66000-00	525-60027-00	525-60028-00
Tygon® (hydrocarbon)	525-73000-00	525-74000-00	525-76000-00	525-70027-00	525-70028-00
Tygon® 2001 (food)	525-83000-00	525-84000-00	525-86000-00	525-80027-00	525-80028-00

### Tubing sizes

				
Inner diameter	(mm)	4.8	6.4	7.9
Outer diameter	(mm)	9.8	11.3	12.9
<b>Wall thickness (wt)</b>	<b>(mm)</b>	<b>2.5</b>	<b>2.5</b>	<b>2.5</b>
Max. pressure (continuous / short time)	(bar)	0.8 / 1.8	0.8 / 1.8	0.8 / 1.8
Suction height	(mH <sub>2</sub> O)	8.8	8.8	8.8

### Average flow rates in combination with pump head and pump drive:

SP quick		4.8		6.4		7.9			
		min.	max.	min.	max.	min.	max.		
Hei-FLOW Advantage o6 / Hei-FLOW Precision o6	(ml/min)	58	1,527	85	2,248	113	3,171		
Hei-FLOW Value o6	(ml/min)	123	1,580	180	2,411	257	3,436		
Hei-FLOW Advantage o1 / Hei-FLOW Precision o1	(ml/min)	12	299	18	435	25	630		
Hei-FLOW Value o1	(ml/min)	26	299	38	454	50	636		
SP standard / SP vario		min.		max.		min.		max.	
Hei-FLOW Advantage o6 / Hei-FLOW Precision o6	(ml/min)	92		2,390		139		3,821	
Hei-FLOW Value o6	(ml/min)	203		2,426		313		3,782	
Hei-FLOW Advantage o1 / Hei-FLOW Precision o1	(ml/min)	15		491		28		769	
Hei-FLOW Value o1	(ml/min)	42		493		68		773	

### Tubing P/N (per meter):

Silicone	525-35000-00	525-39000-00	525-32000-00
Viton®	525-55000-00	525-59000-00	525-52000-00
PharMed®	525-25000-00	525-29000-00	525-22000-00
Tygon® (standard)	525-65000-00	525-69000-00	525-62000-00
Tygon® (hydrocarbon)	525-75000-00	525-79000-00	525-72000-00
Tygon® 2001 (food)	525-85000-00	525-89000-00	-

## ▶ Multi-Channel Pumps

### These pump drives can be configured for multi-channel use:

Hei-FLOW Value o1,  
Hei-FLOW Advantage o1,  
Hei-FLOW Precision o1

- Increase your throughput by running up to 12 individual cassettes on one single pump drive and pump head system
- Separate metering into multiple vessels with different feed rates in a single operation by using different tubing dimensions to adjust flow rate
- Save time: tubing change is done in just seconds

- In addition to standard pump heads which feature a 4-roller system you can choose 8-roller pump heads for low pulsation
- Change your cassettes easily, even during operation – there are no restrictions
- Cassette adjustments and changes are simple, just click in place
- No additional purchase of a pump drive needed: upgrade your single-channel pump drive with just one adaptor for multi-channel use and pick the head/cassette configuration that matches your application needs



Hei-FLOW Advantage o1 + adaptor + pump head C 4 + cassette small

## Multi-channel pump heads



### Multi-channel pump head C 12 P/N 524-81220-00

- Accepts 12 cassettes small
- Built-in reduction gear allows feeding of smallest quantities
- 8 rollers minimizing pulsation



### Multi-channel pump head C 8 P/N 524-40810-00

- Accepts 8 cassettes medium or 4 cassettes large
- 4-roller design



### Multi-channel pump head C 4 P/N 524-80420-00

- Accepts 4 cassettes small
- 8 rollers for low pulsation

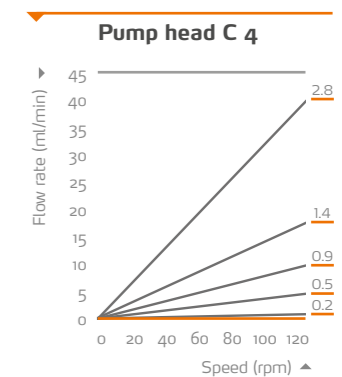
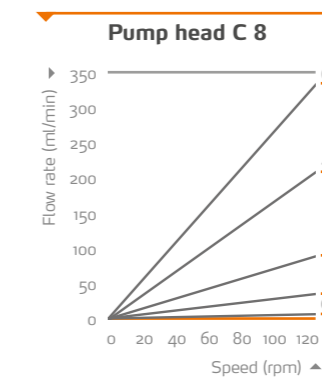
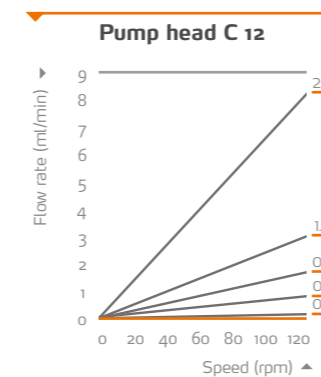

Flow rates pertain to water



## Multi-Channel Cassettes

- Setting screws to adjust roller contact pressure
- Cassettes easily change even while pumping
- All cassettes accept different tube materials and sizes

Two-Stop Tubing



### Cassette small

- Flow rates from 0.005 to 37 ml/min
- Suitable for tubes with 0.9-mm wall thickness (wt)
- Tube diameters available: 0.2 / 0.5 / 0.9 / 1.4 and 2.8 mm
- Two-Stop Tubing (40 cm) required to operate cassette small
- Stoppers secure tube in place
- Couplings and tube extensions allow extra hose length in 1-m increments
- Combinations:
  - C 4 multi-channel pump head: Max. 4 cassettes small
  - C 12 multi-channel pump head: Max. 12 cassettes small

Cassette small  
P/N 524-90022-00



### Cassette medium

- Flow rates from 0.24 to 27 ml/min
- Suitable for tubes with 1.6-mm wall thickness (wt)
- Tube diameters available: 0.8 and 1.7 mm
- Tube available in requested sizes
- Combinations:
  - C 8 multi-channel pump head: Max. 8 cassettes medium

Cassette medium  
P/N 524-90021-00



### Cassette large

- Flow rates from 1 to 364 ml/min
- Suitable for tubes with 1.6-mm wall thickness (wt)
- Tube diameters available: 1.7 / 3.1 / 4.8 and 6.4 mm
- Tube available in requested sizes
- Combinations:
  - C 8 multi-channel pump head: Max. 4 cassettes large

Cassette large  
P/N 524-90010-00



## Tubing Sizes for Multi-Channel Pumps

Tubing sizes		0.2	0.5	0.9	1.4	2.8
Inner diameter	(mm)	0.25	0.51	0.89	1.42	2.79
Outer diameter	(mm)	2.05	2.31	2.69	3.22	4.59
Wall thickness (wt)	(mm)	0.9	0.9	0.9	0.9	0.9
Max. pressure (continuous / short time)	(bar)	0.5 / 1.5	0.5 / 1.5	0.5 / 1.5	0.5 / 1.5	0.5 / 1.5
Suction height	(mH <sub>2</sub> O)	7	7	7	7	7

#### Average flow rates in combination with cassette, pump head and pump drive:

Hei-FLOW Advantage 01 / Hei-FLOW Precision 01	min.	max.	min.	max.	min.	max.	min.	max.	min.	max.	max. number of cassettes
Cassette small / pump head C 12 (ml/min)	0.005	0.11	0.01	0.54	0.03	1	0.10	3	0.29	9	12
Cassette small / pump head C 4 (ml/min)	0.02	0.49	0.08	2	0.24	6	0.60	14	2	36	4
Hei-FLOW Value 01	min.	max.	min.	max.	min.	max.	min.	max.	min.	max.	
Cassette small / pump head C 12 (ml/min)	0.005	0.11	0.02	0.42	0.10	1	0.23	3	0.69	8	12
Cassette small / pump head C 4 (ml/min)	0.04	0.53	0.17	2	0.57	6	1	15	4	37	4

#### Tubing P/N:

Silicone	Two-Stop Tubing for cassette small			525-30014-00	525-30015-00	525-30016-00
	Extension tube (per meter)			525-30024-00	525-30025-00	525-30026-00
Viton®	Two-Stop Tubing for cassette small			525-50014-00	525-50015-00	525-50016-00
	Extension tube (per meter)			525-50024-00	525-50025-00	525-50026-00
PharMed®	Two-Stop Tubing for cassette small	525-20012-00	525-20013-00	525-20014-00	525-20015-00	525-20016-00
	Extension tube (per meter)	525-20022-00	525-20023-00	525-20024-00	525-20025-00	525-20026-00
Tygon® (standard)	Two-Stop Tubing for cassette small	525-60012-00	525-60013-00	525-60014-00	525-60015-00	525-60016-00
	Extension tube (per meter)	525-60022-00	525-60023-00	525-60024-00	525-60025-00	525-60026-00
Fittings for extension tubes (PTFE)		526-22000-00	526-22000-00	526-22000-00	526-22000-00	526-22000-00

Tubing sizes		0.8	1.7	3.1	4.8	6.4
Inner diameter	(mm)	0.8	1.7	3.1	4.8	6.4
Outer diameter	(mm)	4	4.9	6.3	8	9.5
Wall thickness (wt)	(mm)	1.6	1.6	1.6	1.6	1.6
Max. pressure (continuous / short time)	(bar)	0.7 / 1.7	0.7 / 1.7	0.7 / 1.7	0.7 / 1.7	0.5 / 1.5
Suction height	(mH <sub>2</sub> O)	8.8	8.8	8.8	8.8	6.7

#### Average flow rates in combination with cassette, pump head and pump drive:

Hei-FLOW Advantage 01 / Hei-FLOW Precision 01	min.	max.	min.	max.	min.	max.	min.	max.	min.	max.	max. number of cassettes
Cassette medium / pump head C 8 (ml/min)	0.24	7	1	26							8
Cassette large / pump head C 8 (ml/min)			1	27	4	90	8	192	11	329	4
Hei-FLOW Value 01	min.	max.	min.	max.	min.	max.	min.	max.	min.	max.	
Cassette medium / pump head C 8 (ml/min)	0.55	6.97	2.17	27							8
Cassette large / pump head C 8 (ml/min)			2	27	7	85	18	246	26	364	4

#### Tubing P/N (per meter):

Silicone	525-33000-00	525-34000-00	525-36000-00	525-30027-00	525-30028-00
Viton®	525-53000-00	525-54000-00	525-56000-00	525-50027-00	525-50028-00
PharMed®	525-23000-00	525-24000-00	525-26000-00	525-20027-00	525-20028-00
Tygon® (standard)	525-63000-00	525-64000-00	525-66000-00	525-60027-00	525-60028-00
Tygon® (hydrocarbon)	525-73000-00	525-74000-00	525-76000-00	525-70027-00	525-70028-00
Tygon® 2001 (food)	525-83000-00	525-84000-00	525-86000-00	525-80027-00	525-80028-00

Flow rates pertain to Tygon® (standard) tubing and water

## ➤ Tubing Options

### Tygon® standard

- **Application:** For standard applications
- **Features:**
  - Non-toxic, non-oxidizing
  - Good resistance to acids, bases and inorganic media
  - Very low gas permeability, good performance life
- **Material:** Thermoplastic soft PVC, transparent
- **Complies with the standards:** FDA (21 CFR 177.2601) and GLP
- **Temperature range:** -50 to +75 °C
- **Sterilization:** Can be autoclaved for 30 min at 1 bar and 120 °C (material may change color) or with ethylene oxide
- **Restriction:** Segregation of plasticizers is possible



- **Use with:**

Acids:	good
Lyes:	good
Solvents:	unsuitable
Pressure:	good
Vacuum:	good
Viscous media:	excellent
Sterile media:	conditional

### PharMed®

- **Application:** Ideal for medical, lab and research uses
- **Features:**
  - High fatigue strength under repeated reversed bending stresses
  - Non-toxic, biocompatible
  - Very low gas permeability
  - Well suited to acids and bases
- **Material:** Thermoplastic elastomer on a polypropylene base with plasticizers; excellent tensile strength; opaque
- **Complies with the standards:** FDA (21 CFR 177.2600), USP Class VI, GLP, Pharmacopoea and Europaea
- **Temperature range:** -51 to +135 °C
- **Sterilization:** Can be autoclaved or sterilized with ethylene oxide or sterilized by irradiation
- **Restriction:** Additives may migrate



- **Use with:**

Acids:	good
Lyes:	good
Solvents:	unsuitable
Pressure:	good
Vacuum:	excellent
Viscous media:	good
Sterile media:	excellent



### Tygon® 2001 for food

- **Application:** Food industry, well suited to products with high fat content
- **Features:**
  - Extremely chemical-resistant; e. g. appropriate for the use of polar solvents
  - Plasticizer and oil-free
  - Superior flex life in peristaltic pumps
  - Translucent to ease visual inspection
  - Outstanding flexibility
- **Material:** Thermoplastic tube, transparent
- **Complies with the standards:** USP Class VI, FDA (21 CFR 177.2600) and GLP
- **Temperature range:** -78 to +71 °C
- **Sterilization:** Can be autoclaved for 30 min at 1 bar, sterilized by irradiation or with ethylene oxide

- **Use with:**

Acids:	excellent
Lyes:	excellent
Solvents:	good
Pressure:	good
Vacuum:	good
Viscous media:	good
Sterile media:	good



- **Use with:**

Acids:	conditional
Lyes:	conditional
Solvents:	unsuitable
Pressure:	satisfactory
Vacuum:	good
Viscous media:	satisfactory
Sterile media:	excellent

### Silicone

- **Application:** Platinum-coated silicone hose for use in pharmaceuticals and biology
- **Features:**
  - Extremely smooth interior prevents bacterial growth
  - Biocompatible, minimal adsorption and absorption
  - Best flow properties, high temperature stability
  - Absolutely inert, softener-free
- **Material:** Polydimethylsiloxane with siliceous earth and silicone additives; translucent white; excellent resistance to initial pressure
- **Complies with the standards:** USP Class VI, FDA, meets GLP and NSF
- **Temperature range:** -80 to +200 °C
- **Sterilization:** Can be autoclaved for 30 min at 1 bar or sterilized by irradiation
- **Restriction:** Not suitable for concentrated solvents, oils, acids or dilute caustic soda; relatively high permeability to gas

### Tygon® for hydrocarbons

- **Application:** Especially for hydrocarbons, mineral oil products and distillates
- **Features:**
  - Ideal for petrol, kerosene, heating oil, cutting solutions and coolants on a glycol base
  - Resistant to ozone and UV
- **Material:** Thermoplastic soft PVC, translucent yellow
- **Complies with the standards:** GLP conform
- **Temperature range:** -40 to +75 °C
- **Sterilization:** Sterilization is not recommended
- **Restriction:** Not suitable for concentrated acids, lyes, food and pharmaceuticals



- **Use with:**

Acids:	good
Lyes:	good
Solvents:	conditional
Pressure:	good
Vacuum:	good
Viscous media:	excellent
Sterile media:	conditional

### Viton®

- **Application:** Excellent acid resistance at high temperatures
- **Features:**
  - Low gas permeability
  - Resistant to solvents and corrosives at high temperatures
- **Material:** Fluorocarbon rubber, thermoformed Viton B (67% fluorinated); opaque black
- **Complies with the standards:** GLP conform
- **Temperature range:** -30 to +205 °C
- **Sterilization:** 16 hours at +250 °C with hot air circulation recommended
- **Restriction:** Limited performance life



- **Use with:**

Acids:	excellent
Lyes:	excellent
Solvents:	varies; tests recommended
Pressure:	good
Vacuum:	good
Viscous media:	good
Sterile media:	satisfactory

# Tubing Compatibility

Chemical	P	S	T	TU	TK	V	Chemical	P	S	T	TU	TK	V	Chemical	P	S	T	TU	TK	V	Chemical	P	S	T	TU	TK	V
A Acetaldehyde	D	C	D	D	D	D	C Calcium oxide	A	A	A	A	A	-	H/J Hydrobromic acid, 20 - 50 %	D	D	A	A	A	A	Potassium hydroxide, <10 % in W.	A	A	A	D	-	B
Acetic acid, 10 % in W.	A	A	A	A	A	-	Carbon bisulfide	D	D	D	D	D	-	Hydrochloric acid, 10 % in W.	A	D	A	A	A	A	Potassium iodide, 56 % in W.	A	A	A	A	A	-
Acetic acid, 100 %	B	D	D	D	-	-	Carbon tetrachloride	D	D	D	D	D	A	Hydrochloric acid, 37 % in W.	B	D	A	D	A	B	Propanol (propyl alcohol)	C	A	D	D	A	B
Acetic anhydride	A	A	D	D	A	D	Chlorine, wet	D	D	B	B	C	B	Hydrocyanic acid	A	A	A	A	A	A	Pyridine	C	D	D	D	C	D
Acetone	D	C	D	D	C	D	Chloroacetic acid, 20 % in W.	B	A	A	D	A	D	Hydrofluoric acid, 10 % in W.	D	D	C	A	A	B	Q/S Silicone oils	C	D	B	A	B	A
Acetonitrile	C	D	D	D	B	D	Chlorobenzene	D	D	D	D	C	A	Hydrofluoric acid, 50 %	D	D	D	D	A	A	Silver nitrate, 55 % in W.	A	A	A	A	A	A
Acetyl bromide	C	D	D	D	C	-	Chloroform	D	D	D	D	C	A	Hydrogen peroxide, 10 % in W.	A	A	A	A	A	A	Soap solutions	B	A	A	A	A	A
Acetyl chloride	C	D	D	D	C	A	Chlorobromomethane	B	D	D	D	-	A	Hydrogen peroxide, 90 % in W.	B	C	D	D	B	-	Sodium bicarbonate, 7 % in W.	A	A	A	A	A	A
Aliphatic hydrocarbons	D	D	D	B	D	-	Chromic acid, 20 % in W.	A	D	B	C	B	A	Hydroiodic acid	B	B	A	A	A	-	Sodium bisulfate	A	-	A	A	A	-
Aluminum chloride, 53 % in W.	A	A	A	A	A	A	Chromic acid, 50 % in W.	C	D	C	D	-	-	Hypochlorous acid, 25 % in W	A	A	A	A	A	A	Sodium borate	A	A	A	A	A	A
Aluminum sulfate, 50 % in W.	A	A	A	A	A	A	Copper salts	A	A	A	A	A	-	Iodine solutions	A	C	A	A	A	-	Sodium carbonate	A	A	A	A	A	B
Alums	A	A	A	A	A	-	Cyclohexane	D	D	D	C	D	A	K/L Ketones	D	D	D	D	C	-	Sodium ferrocyanide	A	A	A	D	-	-
Ammonia, gas and liquid	A	D	B	B	B	D	Cyclohexanone	D	D	D	D	C	D	Lactic acid, 10 % in W.	A	A	A	A	A	-	Sodium hydrosulfite	A	-	A	A	A	-
Ammonium acetate, 45 % in W.	A	A	A	A	A	-	Chlorosulfonic acid	D	D	D	D	D	D	Lactic acid, 85 % in W.	B	D	D	D	-	-	Sodium hydroxide, 10 - 15 % in W.	A	A	A	D	A	B
Ammonium carbonate, 20 % in W.	A	A	A	A	A	A	D Diesel	D	D	D	B	-	-	Lead acetate, 35 % in W.	A	A	A	A	A	-	Sodium hydroxide, 30 - 40 % in W.	A	C	C	D	A	B
Ammonium chloride	A	C	A	A	A	A	Dimethyl formamide	B	B	D	D	A	D	M Manganese salts	A	A	A	A	A	-	Sodium nitrate, 3.5 % in W.	A	A	A	A	A	-
Ammonium hydroxide, 30 % in W.	A	D	A	C	A	B	E Ethanol (ethyl alcohol)	A	B	D	B	A	A	Magnesium chloride, 35 % in W.	A	A	A	A	A	A	Sodium sulfate, 3.6 % in W.	A	A	A	A	-	A
Ammonium nitrate	A	C	A	A	A	-	Ether	C	D	D	C	D	-	Magnesium sulfate, 25 % in W.	A	A	A	A	A	-	Sodium sulfide, 13 % in W.	A	A	A	A	A	-
Ammonium phosphate	A	A	A	A	A	-	Ethyl acetate	B	D	D	D	D	D	Mercury salts	A	A	A	A	A	-	Stearic acid, 5 % in Alc.	C	D	D	B	B	-
Ammonium sulfate	B	A	A	A	A	D	Ethyl bromide	D	D	D	D	C	-	Methane	A	-	A	A	A	A	Sulfuric acid, 10 % in W.	A	A	A	B	A	A
Amyl acetate	B	D	D	D	D	A	Ethyl chloride	C	D	D	D	D	A	Methanol	A	B	D	B	A	D	Sulfuric acid, 30 % in W.	A	B	A	B	A	A
Amyl alcohol	D	D	D	A	A	A	Ethylamine	D	C	D	D	B	-	Methyl Ethyl Ketone	D	D	D	D	C	D	Sulfuric acid, 95 - 98 % in W.	D	D	D	D	C	A
Amyl chloride	C	D	D	D	D	-	Ethylene chlorhydrin	A	B	D	B	A	A	Monoethanolamine	C	D	D	D	D	D	Sulfurous acid	A	A	A	A	A	A
Aniline	C	D	D	D	D	D	Ethylene dichloride	C	D	D	D	D	B	N Naphtha	D	D	D	D	D	A	T Tannic acid, 75 % in W.	B	A	B	D	A	-
Aniline hydrochloride	C	D	D	D	D	B	Ethylene glycol	A	A	A	A	A	A	Nickel salts	A	A	A	A	A	-	Tartaric acid, 56 % in W.	A	A	A	A	A	A
Aqua regia (80 % HCl, 20 % HNO <sub>3</sub> )	D	D	D	D	A	-	Ethylene oxide	A	D	A	A	A	D	Nitric acid, 10 % in W.	A	C	A	D	A	A	Tin salts	A	A	A	A	A	-
Aromatic hydrocarbons	A	D	D	D	D	-	F Fatty acids	C	B	B	C	C	C	Nitric acid, 35 % in W.	A	D	A	D	A	A	Toluene (toluol)	D	D	D	D	C	A
Arsenic salts	A	A	A	A	A	-	Ferric chloride 40 % in W.	A	A	A	A	A	B	Nitric acid, 68 - 71 % in W.	D	D	D	D	D	-	Trichloroacetic acid, 90 % in W.	B	D	A	D	A	C
B Barium salts	A	A	A	A	A	-	Ferric sulfate 5 % in W.	A	A	A	A	A	A	Nitrobenzene	D	D	D	D	C	-	Trichlorethylene	C	D	D	D	C	A
Benzaldehyde	D	C	D	D	C	D	Ferrous chloride 43 % in W.	A	A	A	A	A	-	Nitrous acid, 10 % in W.	A	B	A	C	A	-	Trisodium phosphate	A	A	A	A	A	A
Benzene	D	D	D	D	-	-	Ferrous sulfate 5 % in W.	A	A	A	A	A	-	O Oils, animal	C	A	D	A	B	-	Turpentine	D	D	D	B	A	A
Benzenesulfonic acid	D	D	D	D	D	A	Fluoboric acid, 10 % in W.	D	D	A	A	A	-	Oils, mineral	D	D	C	A	D	A	Urea, 20 % in W.	A	A	A	A	A	-
Boric acid, 4 % in W.	A	A	A	A	A	A	Fluoroborate salts	A	-	A	A	A	-	Oleic acid	C	B	D	B	D	B	Uric acid	A	A	A	C	A	-
Bromine	D	D	D	D	D	A	Fluosilicic acid	C	B	D	B	A	-	P Perchloric acid, 67 % in W.	A	D	C	D	A	A	Xylene	D	D	D	D	C	B
Butane	A	A	A	A	B	A	Formaldehyde, 37 % in W.	D	C	D	D	C	D	Perchloroethylene	C	D	D	D	D	A	W/Z Zinc chloride, 80 % in W.	A	A	A	A	A	A
Butanol (butyl alcohol)	D	B	D	A	A	A	Formic acid, 25 % in W.	A	A	A	C	A	D	Phenol, 91 % in W.	A	D	D	C	A	-							
Butyl acetate	B	D	D	D	D	-	Freon 11	A	A	A	A	-	-	Phosphoric acid 25 % in W.	A	D	A	A	A	A							
Butyric acid	B	D	D	C	D	D	Fruit juice	A	A	A	A	A	A	Phthalic acid, 9 % in Alc.	A	B	D	C	B	-							
							G Gasoline, high-aromatic	D	D	D	B	D	A	Potassium carbonate, 55 % in W.	A	A	A	A	A	-							
							Gasoline, non-aromatic	D	D	D	B	D	A	Potassium cyanide, 33 % in W.	A	A	A	A	-	-							
							Glycerin	A	A	A	A	A	A														

**Tubing:**  
P = PharMed®  
S = Silicone  
T = Tygon® standard  
TU = Tygon® for hydrocarbons  
TK = Tygon® 2001 for food  
V = Viton®

**Resistance:**  
A = excellent  
B = good  
C = conditional  
D = unsuitable  
- = not tested

**Please note:**  
- All information provided here is not guaranteed to be correct  
- Recommended testing of tubing prior to application use

## ➤ Accessories



### Foot-pedal

P/N 526-14100-00

For start and stop  
(Hei-FLOW Advantage 01 / Hei-FLOW Advantage 06 and Hei-FLOW Precision 01 / Hei-FLOW Precision 06 only)



### Adaptor for multi-channel pump heads

P/N 526-16000-00

To connect pump drive to multi-channel pump head

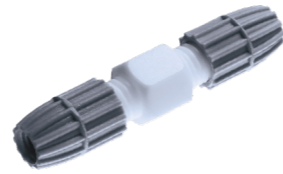

### Fitting for extension tubes

P/N 526-22000-00

For tubing diameter 0.2 - 2.8 mm

## ➤ Hei-FLOW Packages

### Hei-FLOW Silver 1 Package

P/N 523-50019-00

#### Package includes:

- Pump Hei-FLOW Value 01
- Pump head SP quick 1.6
- Each 1-m Tygon tubing and Silicone tubing (inner dia. 3.1 mm)

### Hei-FLOW Gold Package

P/N 523-51019-00

#### Package includes:

- Pump Hei-FLOW Advantage 01
- Pump head SP quick 1.6
- Each 1-m Tygon tubing and Silicone tubing (inner dia. 0.8 mm)

### Hei-FLOW Platinum Package

P/N 523-52019-00

#### Package includes:

- Pump Hei-FLOW Precision 01
- Pump head SP quick 1.6
- Each 1-m Tygon tubing and Silicone tubing (inner dia. 0.8 mm)

### Hei-FLOW Silver 2 Package

P/N 523-50068-00

#### Package includes:

- Pump Hei-FLOW Value 06
- Pump head standard 2.5
- Each 1-m Tygon tubing and Silicone tubing (inner dia. 6.4 mm)

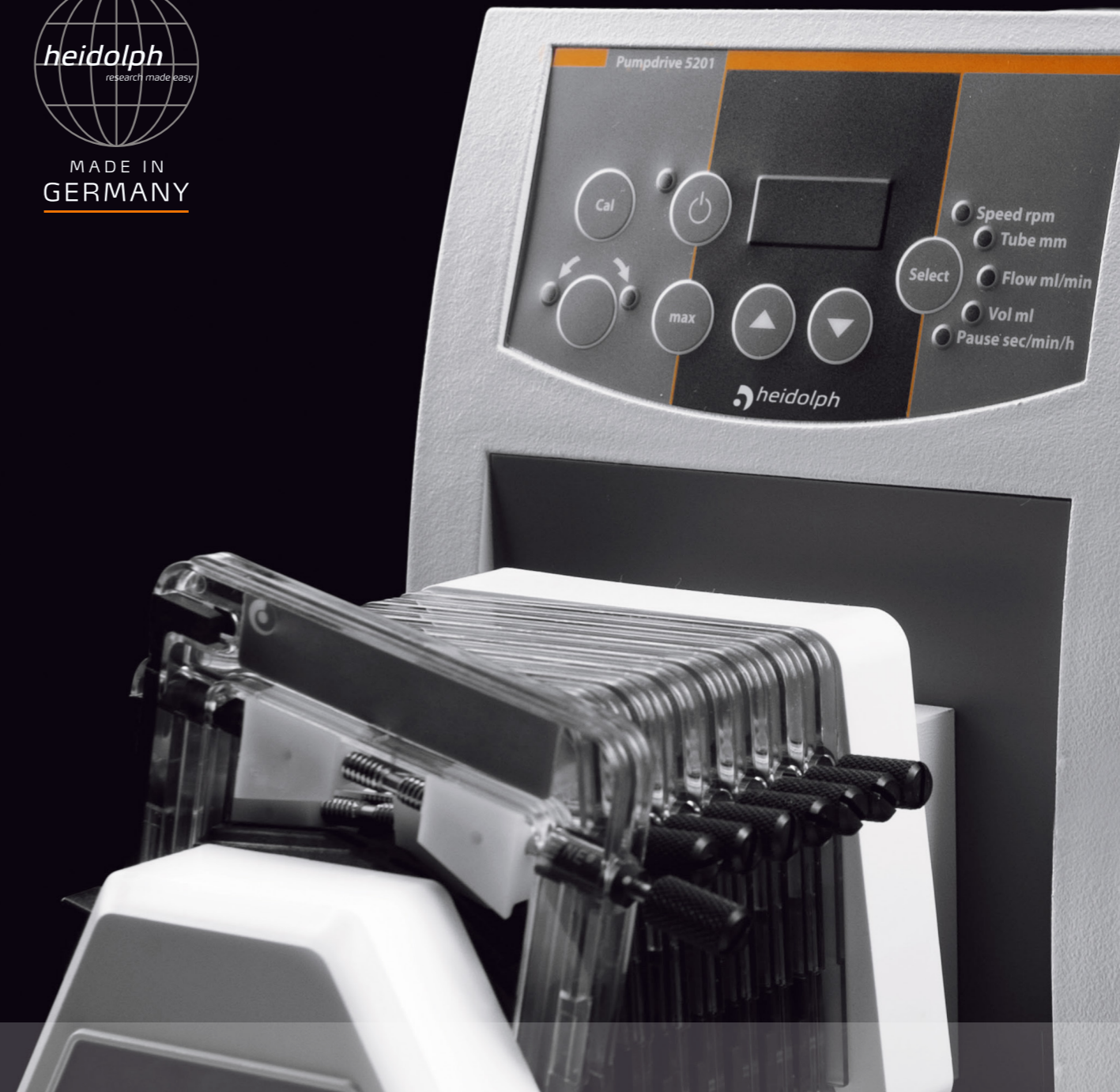

[www.heidolph.com](http://www.heidolph.com)

## Technical Specifications - Peristaltic Pumps

Model	Hei-FLOW Value 01	Hei-FLOW Value 06	Hei-FLOW Advantage 01	Hei-FLOW Advantage 06	Hei-FLOW Precision 01	Hei-FLOW Precision 06
<b>P/N (230 V)</b>	523-50010-00	523-50060-00	523-51010-00	523-51060-00	523-52010-00	523-52060-00
<b>P/N (230 V) incl. multi-channel adaptor</b>	523-50013-00	-	523-51013-00	-	523-52013-00	-
<b>Flow rates single-channel pumps (ml/min)</b>	0.83 - 861	4.0 - 4,151	0.38 - 813	2.0 - 4,056	0.38 - 813	2.0 - 4,056
<b>Flow rates multi-channel pumps (ml/min)</b>	0.005 - 364	-	0.005 - 329	-	0.005 - 364	-
<b>Flow rate accuracy *</b> (%)	±5	±5	±3.5	±3.5	±1	±2
<b>Speed range (rpm)</b>	10 - 120	50 - 600	5 - 120	24 - 600	5 - 120	24 - 600
<b>Speed setting</b>	scale	scale	scale	scale	digital	digital
<b>Electronic speed control</b>	digital	digital	digital	digital	digital	digital
<b>Control accuracy motor (%)</b>	±0.5	±0.5	±0.5	±0.5	±0.5	±0.5
<b>Select direction of rotation</b>	CW / CCW	CW / CCW	CW / CCW	CW / CCW	CW / CCW	CW / CCW
<b>Motor power (W)</b>	100	100	100	100	100	100
<b>Supply power (W)</b>	100	100	100	100	100	100
<b>Analog interface</b>	-	-	for speed 0 - 10 V / 4 - 20 mA direction of rotation start/stop	for speed 0 - 10 V / 4 - 20 mA direction of rotation start/stop	for speed 0 - 10 V / 4 - 20 mA direction of rotation start/stop	for speed 0 - 10 V / 4 - 20 mA direction of rotation start/stop
<b>Digital interface</b>	-	-	-	-	RS 232	RS 232
<b>Flow rate indicator</b>	-	-	-	-	digital	digital
<b>Volume dosing (ml)</b>	-	-	-	-	0.001 - 9,999	0.001 - 9,999
<b>Interval dosing (ml)</b>	-	-	-	-	0.001 - 9,999 in breaks 0.1 sec - 750 h	0.001 - 9,999 in breaks 0.1 sec - 750 h
<b>Smooth start</b>	-	-	-	-	yes	yes
<b>Electronic brake</b>	-	-	-	-	yes	yes
<b>Foot-pedal connection</b>	-	-	yes	yes	yes	yes
<b>Continuous operation (hours/days)</b>	24/7	24/7	24/7	24/7	24/7	24/7
<b>Safety feature</b>	overheat protection	overheat protection	electronic current limiter and overheat protection	electronic current limiter and overheat protection	electronic current limiter and overheat protection	electronic current limiter and overheat protection
<b>Weight (kg)</b>	7.6	7.1	7.6	7.3	7.7	7.3
<b>Protection class (DIN EN 60529)</b>	IP 55	IP 55	IP 55	IP 55	IP 55	IP 55
<b>Permissible ambient conditions</b>	5 - 31 °C at 80 % rel. humidity 32 - 40 °C decreasing linearly up to max. 50 % rel. humidity	5 - 31 °C at 80 % rel. humidity 32 - 40 °C decreasing linearly up to max. 50 % rel. humidity	5 - 31 °C at 80 % rel. humidity 32 - 40 °C decreasing linearly up to max. 50 % rel. humidity	5 - 31 °C at 80 % rel. humidity 32 - 40 °C decreasing linearly up to max. 50 % rel. humidity	5 - 31 °C at 80 % rel. humidity 32 - 40 °C decreasing linearly up to max. 50 % rel. humidity	5 - 31 °C at 80 % rel. humidity 32 - 40 °C decreasing linearly up to max. 50 % rel. humidity
<b>Dimensions (w x d x h) (mm)</b>	166 x 256 x 225	166 x 256 x 225	166 x 256 x 225	166 x 256 x 225	166 x 256 x 225	166 x 256 x 225

\* Flow-rate accuracy pertains to water without counter pressure  
Standard supply voltage: 230 V - other voltages upon request, please specify for order

# Certificate

To confirm the ability for  
continuous operation  
of the Hei-FLOW series Peristaltic Pumps

The Hei-FLOW series Peristaltic Pumps feature overtemperature safety circuits according to DIN EN 61010-1:2001 and DIN EN 61010-2-051:2015 and therefore is designed for continuous operation.

This statement is made under the precondition that all units are operated in accordance with the operation manual and in accordance with good practice standards for safety in laboratories, rules for accident preventions, and compliance with directions on hazardous materials.

Schwabach, January 2018



Stefan Peters  
Research and Development Manager



Marcell Sarré  
Quality Manager



# Hei-Lab App

Research made easy!

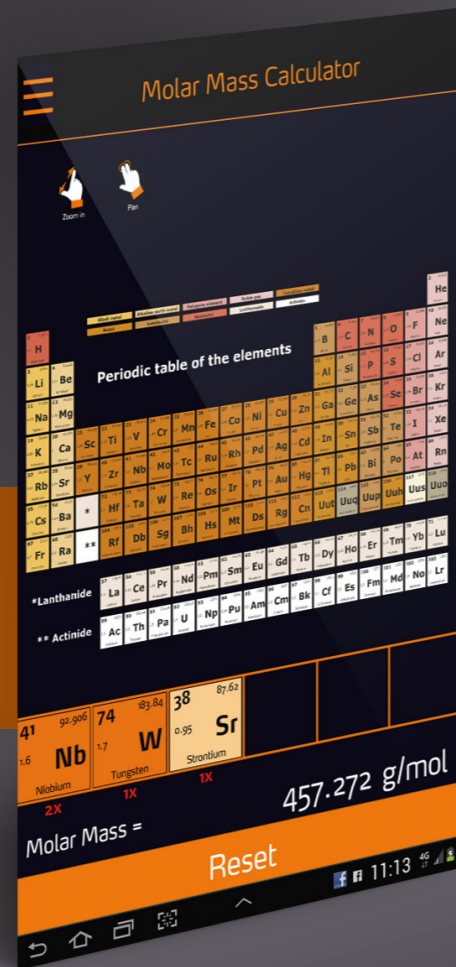
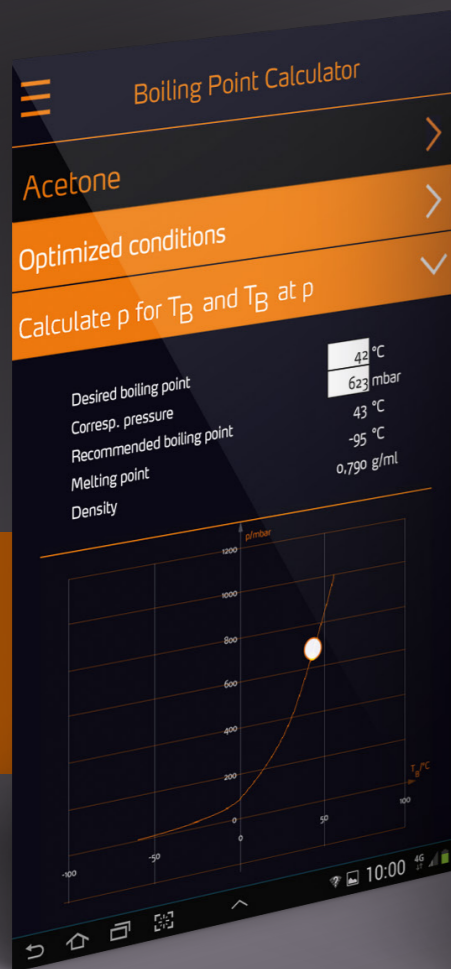

➤ Boiling point calculator for 39 solvents

➤ Molar mass calculator

...and much more



Get the Hei-Lab App for free at



## Technical Service



Jan Lechner  
Extension: +49 9122/9920-74  
Jan.Lechner@heidolph.de



Sven Struller  
Extension: +49 9122/9920-46  
Sven.Struller@heidolph.de



Uwe Kreichauf  
Extension: +49 9122/9920-92  
Uwe.Kreichauf@heidolph.de



Jürgen Heider  
Extension: +49 9122/9920-147  
juergen.Heider@heidolph.de

Jan Lechner, Sven Struller, Jürgen Heider and Uwe Kreichauf are responsible for all Technical Service Operations of the Repair Department. This team assists researchers and distributors in after-sales subjects worldwide.

- Professional product repairs performed at authorized repair facilities
- Repair turn-around time within 4 days
- No-charge quotes for all repairs
- No-charge loaners are often available during repair period
- Most repair facilities will organize logistics on your behalf

## ➤ IQ-OQ Documentation & Certification

### IQ-OQ Certification for Rotary Evaporators

**IQ-OQ Documentation** for Hei-VAP models  
P/N 01-001-015-58

**IQ-OQ Execution** for Hei-VAP models  
P/N 01-001-015-60

### IQ-OQ Certification for Large-Scale Rotary Evaporators

**IQ-OQ Documentation** for Hei-VAP Industrial models  
P/N 01-001-015-52

**IQ-OQ Execution** for Hei-VAP Industrial models  
P/N 01-001-015-53

### IQ-OQ Certification for Automatic Module Distimatic

**IQ-OQ Documentation** for Distimatic  
P/N 01-001-015-62

**IQ-OQ Execution** for Distimatic  
P/N 01-001-015-64

All our Premium Distributors have successfully completed the required qualifications for the Heidolph Premium Distributor Program. They are all committed to execute the following services and are pleased to serve you at the highest level of service requirements in the industry!

## Certificate

Standard **ISO 9001:2015**  
 Certificate Registr. No. **01 100 1600316**

---

Certificate Holder:   
**Heidolph Instruments GmbH & Co. KG**  
 Walpersdorfer Str. 12  
 D - 91126 Schwabach

Scope: Development, production and sales of laboratory equipment

Proof has been furnished by means of an audit that the requirements of ISO 9001:2015 are met.

Validity: The certificate is valid from 2017-09-11 until 2019-10-31.

2017-09-13   
 LGA InterCert GmbH  
 Tillystr. 2 · 90431 Nuremberg

[www.lga-intercert.com](http://www.lga-intercert.com)





- Appropriate level inventory on hand to fill orders within short lead times
- Free demo evaluation units for up to 14 days
- The most common spare parts are locally available
- Lead times below 2 weeks for standard equipment
- Repair turn-around time within 4 working days
- Guaranteed response to any request within 24 hours
- Immediate after-sales service



Visit us on [www.heidolph.com](http://www.heidolph.com) for contact details of your dedicated Premium Distributor

### **Imprint**

Published by: **Heidolph Instruments GmbH & Co. KG**  
Walpersdorfer Straße 12  
D - 91126 Schwabach

Publication date: 07/2017

© **Copyright 2017** , **Heidolph Instruments GmbH & Co. KG**  
Not to be reproduced in part or in its entirety without the approval of the publisher. Images are shown for illustration only and may include other equipment or accessories in use.

All the data provided is subject to technical changes and errors.



 **heidolph**  
MADE IN GERMANY



**Heidolph Instruments GmbH & Co. KG**

Walpersdorfer Str. 12 ▪ 91126 Schwabach

Phone +49 91 22/99 20 19 ▪ Fax +49 91 22/99 20 65

Sales@heidolph.de ▪ www.heidolph.com

 **heidolph**  
research made easy